



Product Support Guide

Structural H23 Cantilever

Columns, Bases and Arms



Structural Cantilever

- 4 General Information, Product Description, Code Compliance, Availability and Shipping Locations
- 5 Structural Cantilever Product Overview, Glossary and Components

H23 Cantilever Columns

- 7 Product Code Description and Overall Column Dimensions
- 8 H23 cantilever columns ("L" single and "C" double sided)
- 9 H23 column part numbers
- 10 H23 column shims

H23 Cantilever Bases

- 11 H23 cantilever bases
- 13 H23 cantilever base shims
- 15 H23 anchor distribution

H23 Cantilever Arms

- 16 H23 cantilever arms
- 18 Pipe stop assembly

H23 Minimum Elevations

- 19 Highest arm to top of column
- 20 Distance between arms with and without pipe stop
- 24 Distance from floor to first arm with and without pipe stop



H23 Bracing

- 28 Welded bracing clips
- 29 Horizontal bracing components
- 30 Diagonal "X" bracing components
- 31 Upper bracing components
- 32 Upper bracing requirements
- 33 H23 bracing schematics

H23 Capacity Charts

- 42 H23 Arm capacities
- 42 H23 Single sided "L" lateral column capacities
- 44 H23 Double sided "C" lateral column capacities
- 46 Capacity calculation example

GENERAL INFORMATION

This support guide covers technical information for Structural Cantilever Columns, Bases and Arms. Structural Cantilever is a very effective design solution for odd-size heavy-duty loads.

PRODUCT DESCRIPTION

Cantilever racking is specifically designed to store items with long or varied lengths, such as metal beams, pipes, molding, wooden boards, metal and plastic sheets and a wide range of other materials.

CODE COMPLIANCE

Interlake Mecalux storage systems are designed in compliance with the 2012 edition of the “Specification for the Design, Testing and Utilization of Industrial Steel Storage Rack” published by the Rack Manufacturers Institute (RMI). This specification has been adopted by the American National Standards Institute (ANSI-MH16.1) as a national standard and is referenced by the 2006 International Building Code (IBC). Our designs also comply with the 2007 American Iron and Steel Institute’s (AISI) North American Specification for the Design of Cold-Formed Steel Structural Members. In addition, the Mecalux Group follows the standards set forth by IAS (International Accreditation Service), the City of Los Angeles, the City of Phoenix and Clark County.



AVAILABILITY AND SHIPPING LOCATIONS

Interlake Mecalux Structural Cantilever is manufactured and distributed from our plants located at:

CANTILEVER MANUFACTURING

MATAMOROS
Las Rusias 2700,
Industrial del Norte
Matamoros Tamaulipas, C.P. 87316

TIJUANA
Blvd. Bellas Artes, 9001
Ciudad Industrial Nueva Tijuana
Tijuana, B.C. - C.P. 22444

CANTILEVER DISTRIBUTION

CHICAGO
1600 North 25th Ave.
Melrose Park, IL 60160

DALLAS
12301N Stemmons Freeway,
Suite # 110
Farmers Branch, TX 75234

SAN DIEGO
8607 Ave. De La Fuente
San Diego, CA 92154

ISO 9001:2000 certified, ISO 9001:2000 certified Matamoros, Mexico 87310 and Tijuana, Mexico 22444.

PRODUCT OVERVIEW

The Structural Cantilever H23 storage system consists of columns connected with horizontal and "X" braces. A series of arms are attached to the columns (uprights) and loads are placed on the arms.

Loads may be handled manually when they are lightweight, or by using lift trucks or other appropriate lifting systems when heavy items are involved.

The Cantilever shelves are especially designed to store extra-long loads and are continuous with no vertical dividers.

It is necessary to consider the weights and dimensions of the loads when designing a Cantilever system.

LEVEL HEIGHT

Our cantilever level height includes the height of the load + the height of the arm (3" to 6") + a recommended clearance (4" to 6") between the top of the load and the bottom of the next arm level. Note that our Cantilever Columns are punched every 4", so the Level Height will be created in 4" increments.

e.g. Load height = 40" and arm model is S3"X5.7 (3" High)
40" load + 3" arm + 4" to 6" clear = 47" to 49", in this case we would use a 48" LEVEL HEIGHT (4" increment).

LOAD DEPTH

Determines the length of the necessary arm, that will normally be equal or longer than the product stored. Our standard H23 arm lengths are: 24", 36", 48", 60" and 72".

e.g. Load depth = 46", recommended arm length will be 48".

There are cases where this rule does not apply. In cases of product, like lumber or flat sheets, the product can extend out of the arm. Contact your Interlake Mecalux Sales Representative for more information.

LOAD LENGTH (BAY WIDTH)

The length, deflection and weight of the product will determine the number of supporting arms. This number will also indicate the number of columns that are needed. The minimum recommendation would be for 2 arms to support the load, in this case the load length is divided by 2 and the resulting number will be the bay width to be used. Note that our Cantilever bay widths are between 24" and 96" in 6" increments.

e.g. Load length = 240" / 2 arms = 120" > 96", in this case we would recommend dividing by 3 ARMS.
240" / 3 arms = 80" (we would recommend 84" which is a standard bay width).

LOAD PER ARM

Once the Load Length is determined, we can use the number of arms to calculate how many pounds each arm should be rated for, this is also helpful in determining the Base and Column capacity.

e.g. Load weight = 3,000 lb. and 2 arms will be used
 $3,000 / 2 = 1,500$ lb per arm.

Note that if the Cantilever Arms are not rated for the specific weight, the bay width may need to be recalculated with a higher number of arms in order to lower the pounds per arm, in which case the calculation would be $3,000 / 3 = 1,000$ lb per arm.

COLUMN HEIGHT

The height of the column will be equal to the Level Height X number of Arm levels required + base height. The distance from the top arm to the top of the column should be at least half of the load height. Our standard H23 column heights are: 8', 10', 12', 14', 15', 16', 18', 20', 22', 24', 26', 30', 32', 34', 36' and 38'.

e.g. Level height = 48", 3 arm levels + base H (W8"X18), load height is 40" ($40" / 2 = 20"$ minimum from top arm to top of column)
 $48" \times 3 = 144" + 8"$ (base) = $152" + 40"$ (top load) = $192"$ (16'), in this case we would recommend using a 16' column.

GLOSSARY

Bay: Group that consists of at least 2 columns, any additional columns will increase the number of bays by factor of 1 if they are part of the same row. Our cantilever bay widths are between 24" and 96".

e.g. 2 columns = 1 bay, 3 columns = 2 bays, 4 columns = 3 bays.

Row: A group of bays, the number of bays is determined by how many loads wide the cantilever should hold or the limitation in available space. Rows are united by horizontal and vertical "X" braces.

e.g. Loads require 3 arms / columns wide minimum and row needs to hold 4 loads wide.
 $3 \times 4 = 12$ arms / columns wide (11 bays).

STRUCTURAL COMPONENTS

Interlake Mecalux has developed a heavy-duty cantilever racking system to cover all market needs.

The choice of the most appropriate solution depends on the characteristics of the product to be stored - particularly the

product's weight, size and height.

COLUMNS AND BASES

The Structural Cantilever columns and bases are manufactured using heavy-duty profiles (W8"X18, W8"X24, W10"X26 or W12"X30).

Every column model comes with punch holes for positioning, allowing arms to be placed in 4" intervals; W8" columns have 6 drill holes every 2" for base connections, W10" and W12" columns have 8 drill holes every 2" for base connections.

ARMS

The Structural Cantilever arms are manufactured using heavy-duty profiles (S3"X5.7, S4"X7.7, S5"X10 and S6"X12.5); they come pre-drilled with a 0.5" hole that allows an optional pipe stop assembly to be installed.

SINGLE SIDED (L) CANTILEVER

Single sided Cantilever is normally placed against the walls with access from one side only.

DOUBLE SIDED (C) CANTILEVER

Double sided Cantilever can be used as an alternative that allows access from both sides.

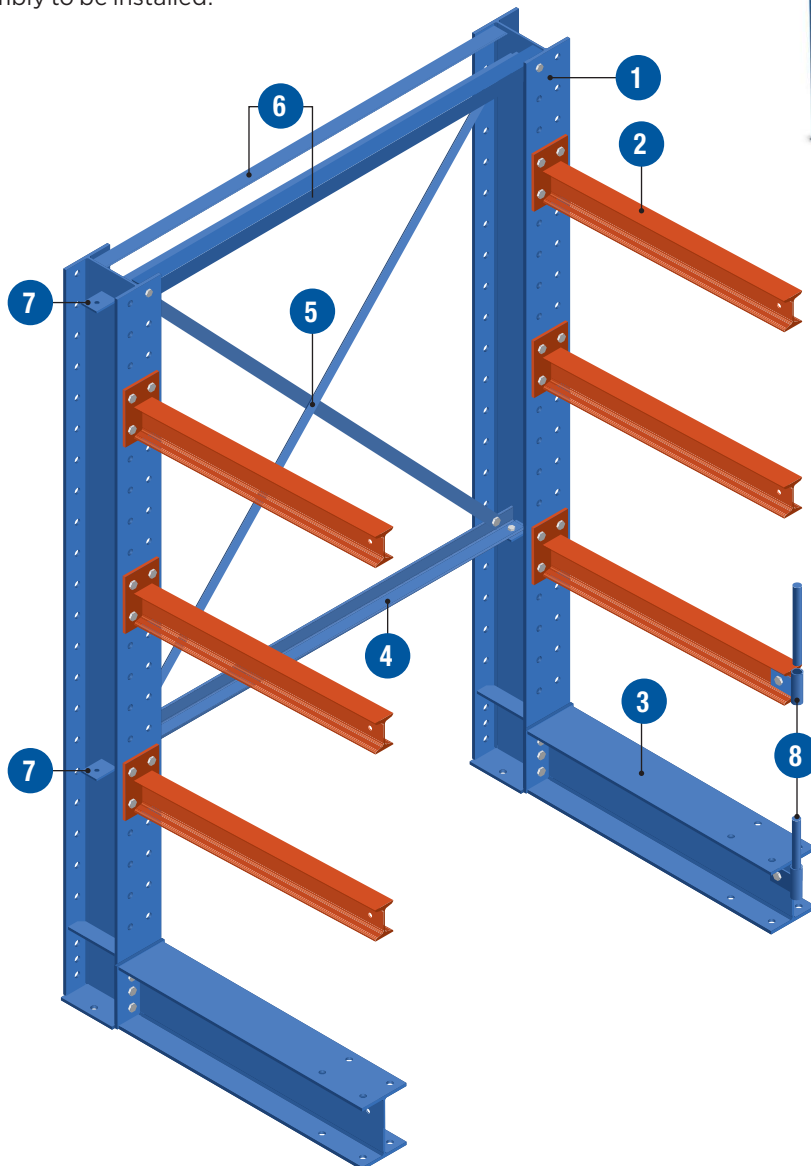
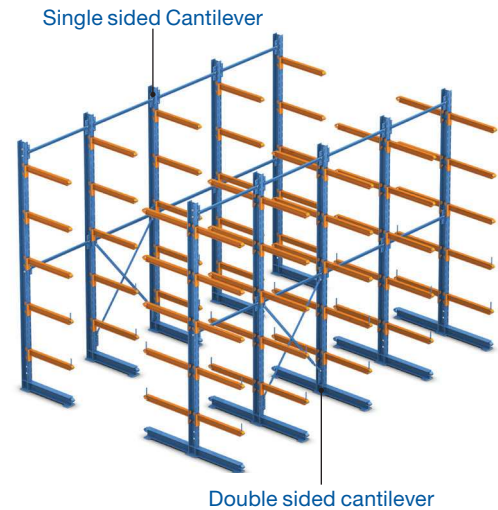

Components

1. Column "W"
2. Arm "S"
3. Base "W"
4. Horizontal bracing
5. Cross bracing ("X" Bracing)
6. Upper horizontal bracing
7. Welded bracing clips
8. Pipe stop assembly (optional)

PRODUCT CODE DESCRIPTION

COL.H23 C W8"X18 U 8'

C = Double Sided
L = Single Sided

Profile Shape

Column Depth (8", 10" or 12")

Pounds per foot (weight)
8" = 18 or 24
10" = 26
12" = 30

Column Height (ft)

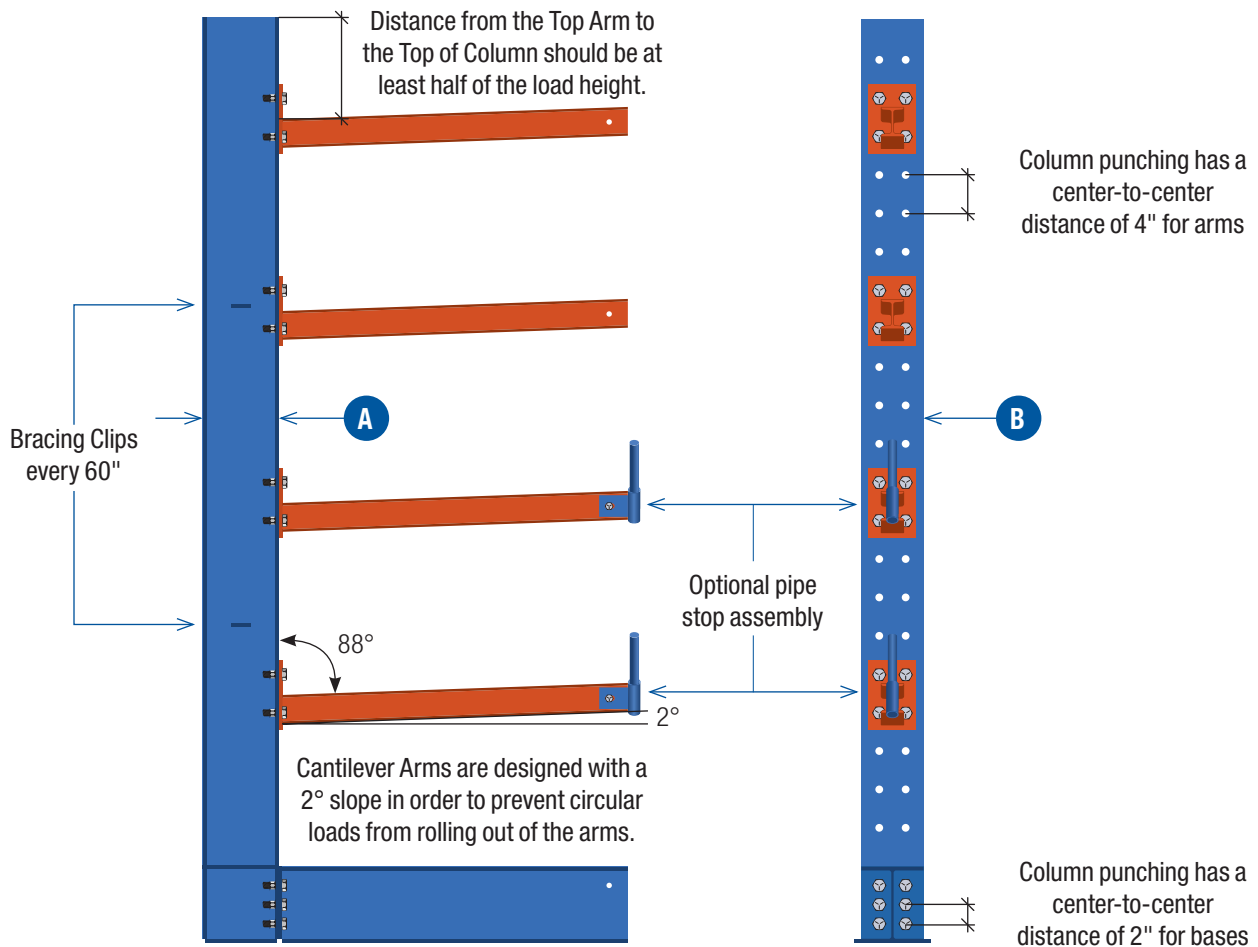

| Overall Column Dimensions | | | | |
|---------------------------|----------|----------|-----------|-----------|
| Model | W8" X 18 | W8" X 24 | W10" X 26 | W12" X 30 |
| A (DEPTH) | 8" | 7.93" | 10.33" | 12.34" |
| B (WIDTH) | 5.25" | 6.49" | 5.77" | 6.52" |

STRUCTURAL CANTILEVER H23

SINGLE (L) AND DOUBLE SIDED (C) COLUMNS

Made with W8", W10" and W12" profiles with holes punched on one flange to create a Single Sided (L) column or holes punched on both flanges to create the Double Sided (C) column, which have been welded to the base plate for slab attachment.

- The following models exist: W8"X18, W8"X24, W10"X26 and W12"X30.
- Hole punches on 4" vertical centers allow the positioning of the arms to the maximum required number of levels.
- Available in standard Mecalux Blue Finish (RAL 5003).
- Standard heights are: 8', 10', 12', 14', 16', 18', 20', 22', 24', 26', 28', 30', 32', 34', 36' and 38'.
- Attached to the slab using (1) Anchor Bolt $\frac{3}{4}$ " X 5 $\frac{1}{2}$ " HILTI TZ (U0077330).

COL.H23 C W8"X18 U 8'

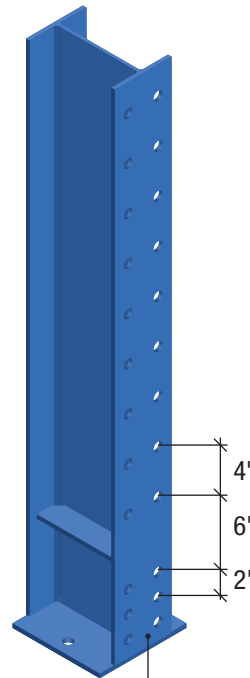
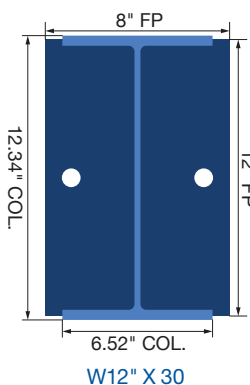
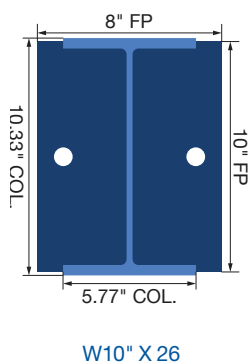
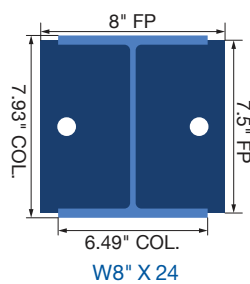
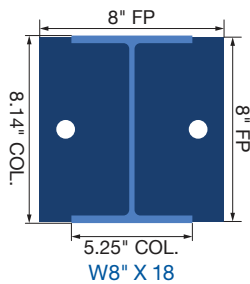
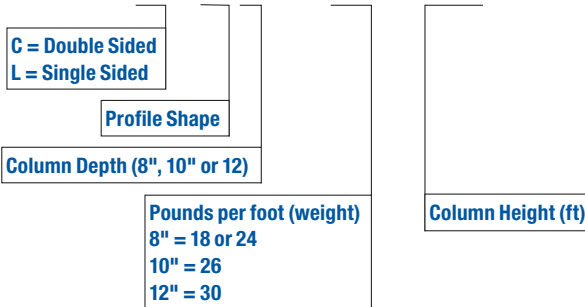

"L" Single Sided
W8" X 18 and W8" X 24

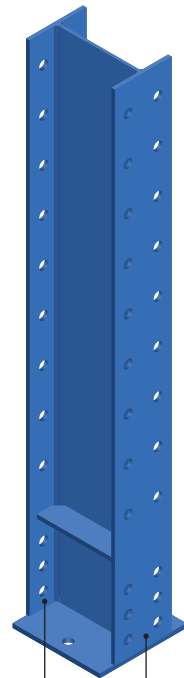

"C" Double Sided
W8" X 18 and W8" X 24

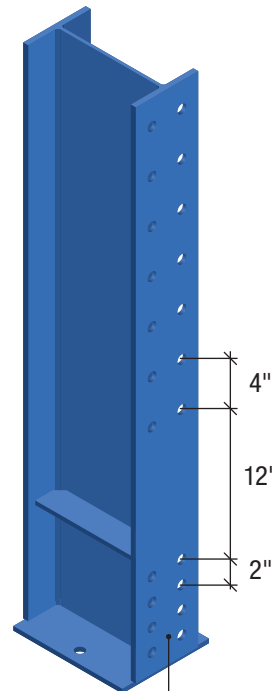

"L" Single Sided
W10" X 26 and W12" X 30

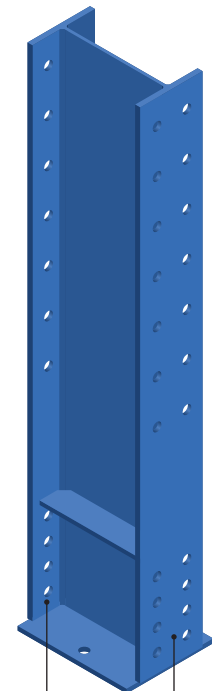

"C" Double Sided
W10" X 26 and W12" X 30

STRUCTURAL CANTILEVER COLUMNS H23

SINGLE (L) AND DOUBLE SIDED (C) COLUMNS PART NUMBERS

| Single Sided "L" Part Numbers | | | | |
|-------------------------------|----------|----------|-----------|-----------|
| Column Height | W8" X 18 | W8" X 24 | W10" X 26 | W12" X 30 |
| 8' | T0210732 | T0210764 | T0210796 | T0210828 |
| 10' | T0210733 | T0210765 | T0210797 | T0210829 |
| 12' | T0210734 | T0210766 | T0210798 | T0210830 |
| 14' | T0210735 | T0210767 | T0210799 | T0210831 |
| 16' | T0210736 | T0210768 | T0210800 | T0210832 |
| 18' | T0210737 | T0210769 | T0210801 | T0210833 |
| 20' | T0210738 | T0210770 | T0210802 | T0210834 |
| 22' | T0210739 | T0210771 | T0210803 | T0210835 |
| 24' | T0210740 | T0210772 | T0210804 | T0210836 |
| 26' | T0210741 | T0210773 | T0210805 | T0210837 |
| 28' | T0210742 | T0210774 | T0210806 | T0210838 |
| 30' | T0210743 | T0210775 | T0210807 | T0210839 |
| 32' | T0210744 | T0210776 | T0210808 | T0210840 |
| 34' | T0210745 | T0210777 | T0210809 | T0210841 |
| 36' | T0210746 | T0210778 | T0210810 | T0210842 |
| 38' | T0210747 | T0210779 | T0210811 | T0210843 |

"L" Single Sided Columns

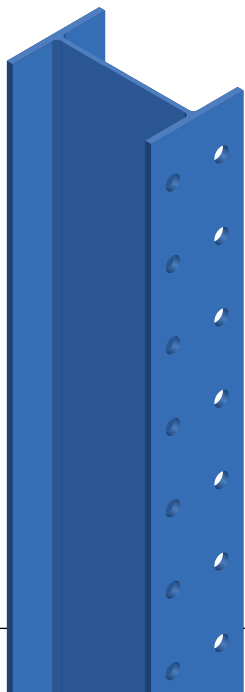

| Double Sided "C" Part Numbers | | | | |
|-------------------------------|----------|----------|-----------|-----------|
| Column Height | W8" X 18 | W8" X 24 | W10" X 26 | W12" X 30 |
| 8' | T0210716 | T0210748 | T0210780 | T0210812 |
| 10' | T0210717 | T0210749 | T0210781 | T0210813 |
| 12' | T0210718 | T0210750 | T0210782 | T0210814 |
| 14' | T0210719 | T0210751 | T0210783 | T0210815 |
| 16' | T0210720 | T0210752 | T0210784 | T0210816 |
| 18' | T0210721 | T0210753 | T0210785 | T0210817 |
| 20' | T0210722 | T0210754 | T0210786 | T0210818 |
| 22' | T0210723 | T0210755 | T0210787 | T0210819 |
| 24' | T0210724 | T0210756 | T0210788 | T0210820 |
| 26' | T0210725 | T0210757 | T0210789 | T0210821 |
| 28' | T0210726 | T0210758 | T0210790 | T0210822 |
| 30' | T0210727 | T0210759 | T0210791 | T0210823 |
| 32' | T0210728 | T0210760 | T0210792 | T0210824 |
| 34' | T0210729 | T0210761 | T0210793 | T0210825 |
| 36' | T0210730 | T0210762 | T0210794 | T0210826 |
| 38' | T0210731 | T0210763 | T0210795 | T0210827 |

"C" Double Sided Columns

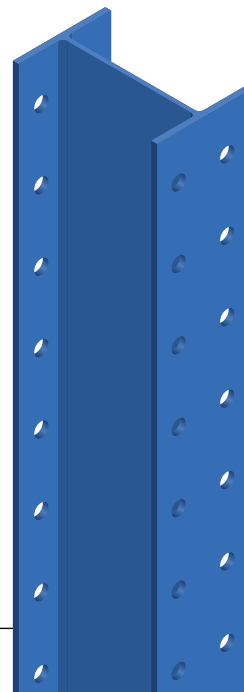

H23 COLUMN SHIMS W8"X18, W8"X24, W10"X26 AND W12"X30

These shims can be placed beneath the H23 cantilever columns to level the upright. One or more shims are required per column.

- Available in standard Galvanized finish.
- GA 11 (0.125").

| H23 Column Shim Part Numbers | | | |
|------------------------------|----------|-----------|-----------|
| W8" X 18 | W8" X 24 | W10" X 26 | W12" X 30 |
| T0210917 | T0210918 | T0210919 | T0210920 |

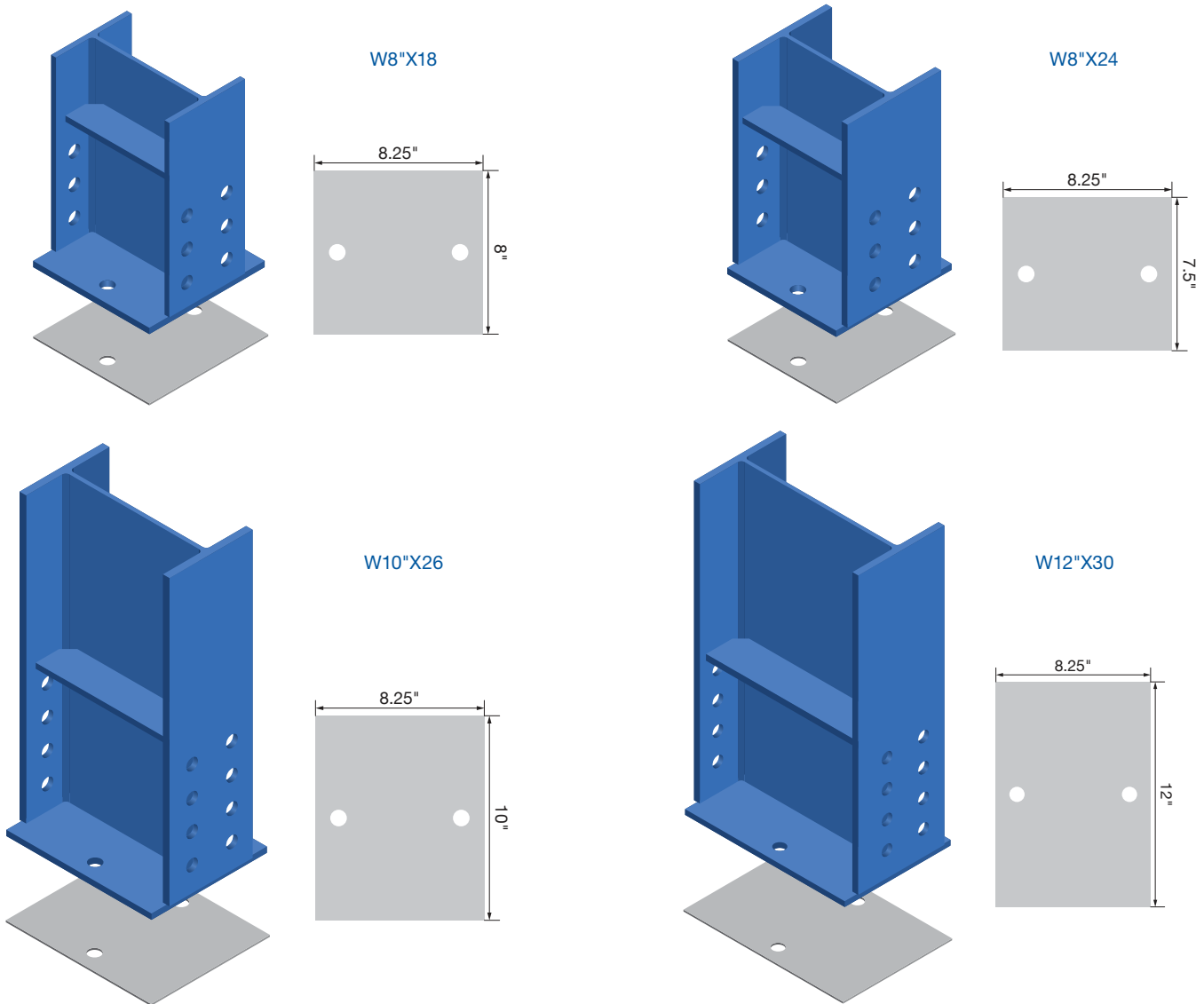

STRUCTURAL CANTILEVER BASE H23 W8"

BASE H23 W8" X18 AND W8" X24

Made with the same structural profile as the columns, includes one welded plate that will help with the connection to the column using (6) Bolts $\frac{3}{4}$ X 2" G5 Z (U0074780) and (6) Nuts $\frac{3}{4}$ -10 G5 Z (U0074695).

- Available in standard Mecalux Blue finish (RAL 5003).
- Standard lengths are: 24", 36", 48", 60" and 72".
- When the base is attached to the column, it becomes the first storage level.
- Attached to the slab using (1) Anchor Bolt $\frac{3}{4}$ X 5 $\frac{1}{2}$ " HILTI TZ (U0077330).

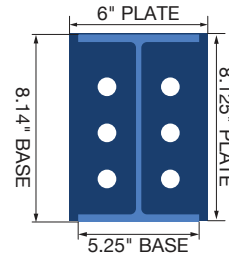

W8" X 18

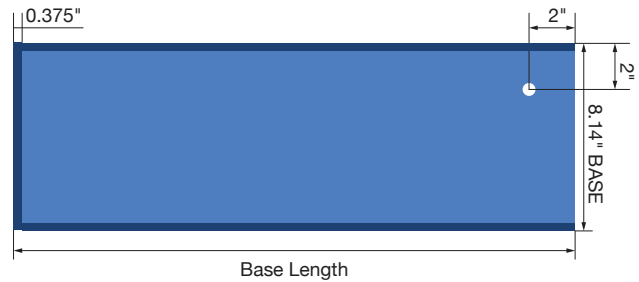

BASE H23 W8" X18 U 2'

Base Height (8", 10" or 12")

Pounds per foot (weight)
8" = 18 or 24
10" = 26
12" = 30

Base Length (ft)

| H23 Base Part Numbers | | | | |
|-----------------------|----------|----------|-----------|-----------|
| Base Length | W8" X 18 | W8" X 24 | W10" X 26 | W12" X 30 |
| 2' | T0210844 | T0210849 | T0210854 | T0210859 |
| 3' | T0210845 | T0210850 | T0210855 | T0210860 |
| 4' | T0210846 | T0210851 | T0210856 | T0210861 |
| 5' | T0210847 | T0210852 | T0210857 | T0210862 |
| 6' | T0210848 | T0210853 | T0210858 | T0210863 |

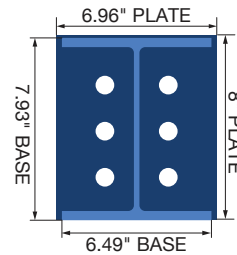

W8" X 24

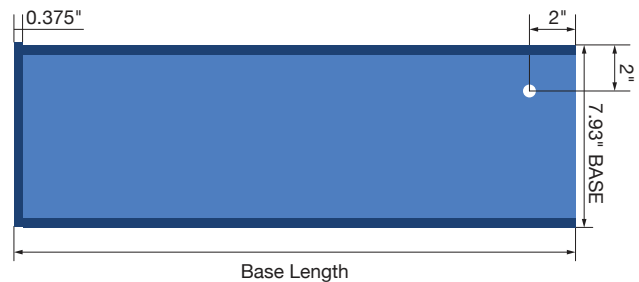

STRUCTURAL CANTILEVER BASE H23 W10" AND W12"

BASE H23 W10"X24 AND W12"X30

Made with the same structural profile as the columns, includes one welded plate that will help with the connection to the column using (8) Bolts $\frac{3}{4}$ X 2" G5 Z (U0074780) and (8) Nuts $\frac{3}{4}$ -10 G5 Z (U0074695).

- Available in standard Mecalux Blue finish (RAL 5003).
- Standard lengths are: 24", 36", 48", 60" and 72".
- When the base is attached to the column, it becomes the first storage level.
- Attached to the slab using (1) Anchor Bolt $\frac{3}{4}$ X 5 $\frac{1}{2}$ " HILTI TZ (U0077330).

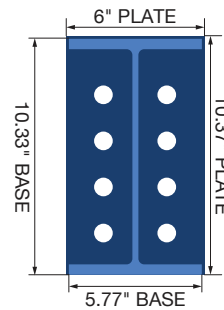

W10" X 26

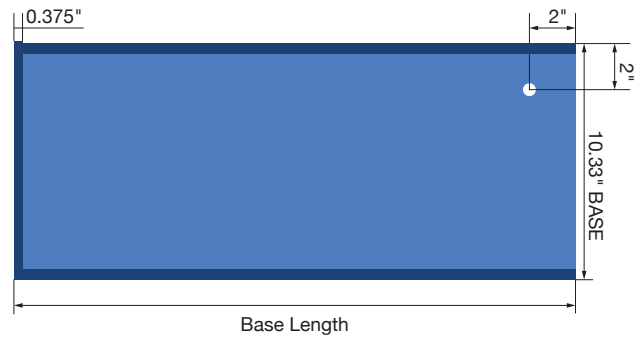

BASE H23 W10"X26 U 2'

Base Height (8", 10" or 12")

Pounds per foot (weight)
8" = 18 or 24
10" = 26
12" = 30

Base Length (ft)

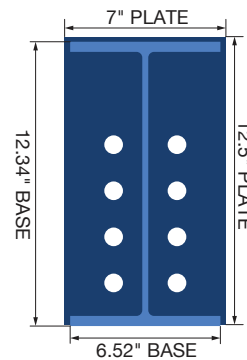

W12" X 30

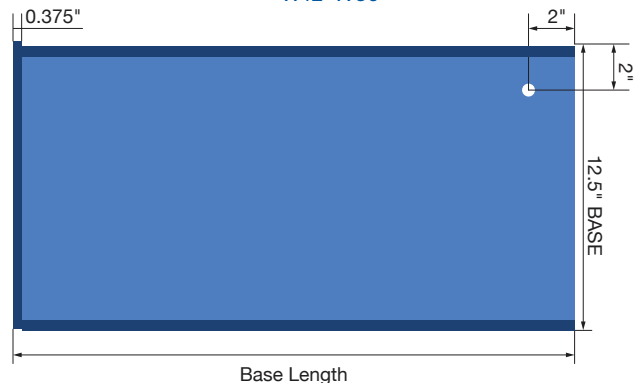

| H23 Base Part Numbers | | | | |
|-----------------------|----------|----------|-----------|-----------|
| Base Length | W8" X 18 | W8" X 24 | W10" X 26 | W12" X 30 |
| 2' | T0210844 | T0210849 | T0210854 | T0210859 |
| 3' | T0210845 | T0210850 | T0210855 | T0210860 |
| 4' | T0210846 | T0210851 | T0210856 | T0210861 |
| 5' | T0210847 | T0210852 | T0210857 | T0210862 |
| 6' | T0210848 | T0210853 | T0210858 | T0210863 |

STRUCTURAL CANTILEVER H23 BASE SHIMS

H23 BASE SHIMS W8"X18 AND W8"X24

These shims can be placed beneath the H23 cantilever bases in order to keep the system level. One or more shims are required per base.

- Available in standard Galvanized finish.
- GA 11 (0.125").

| H23 Base Shim Part Numbers | | | |
|----------------------------|----------|-----------|-----------|
| W8" X 18 | W8" X 24 | W10" X 26 | W12" X 30 |
| T0210921 | T0210922 | T0210923 | T0210924 |

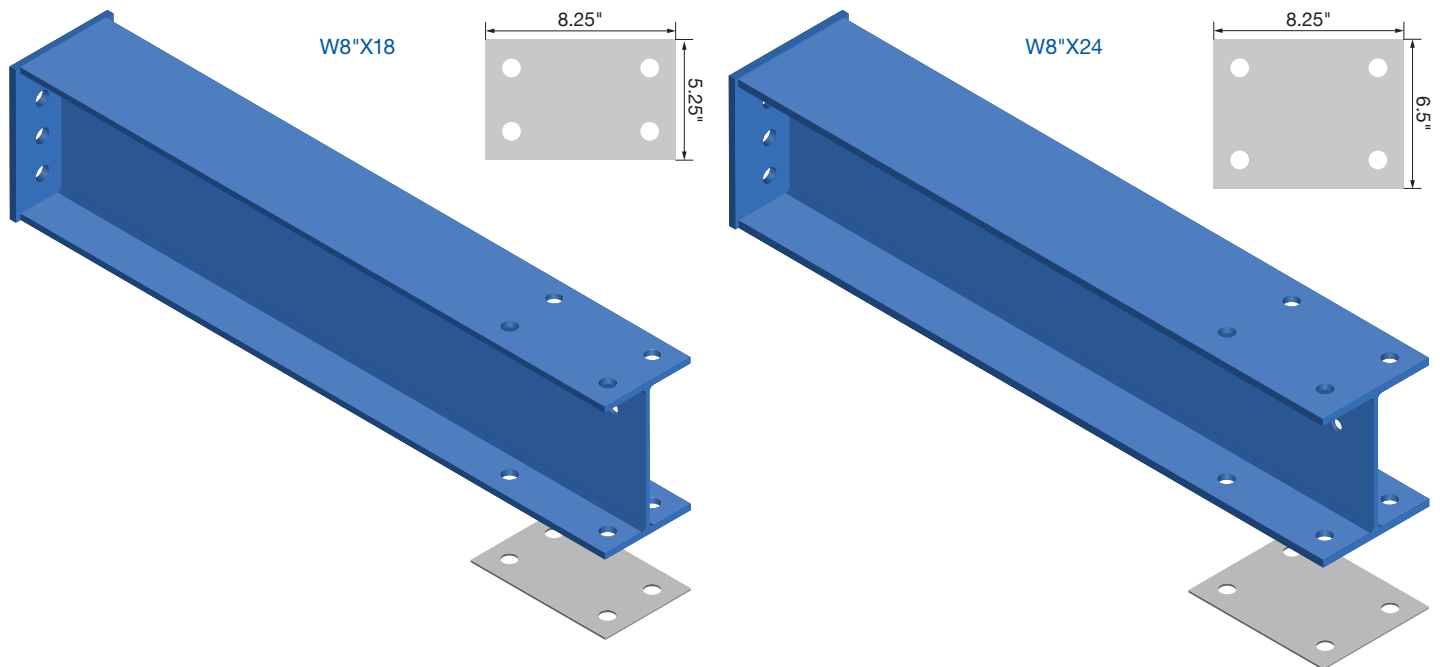

STRUCTURAL CANTILEVER H23 BASE SHIMS

H23 BASE SHIMS W10"X26 AND W12"X30

These shims can be placed beneath the H23 cantilever bases in order to keep the system level. One or more shims are required per base.

- Available in standard Galvanized finish.
- GA 11 (0.125").

| H23 Base Shim Part Numbers | | | |
|----------------------------|----------|-----------|-----------|
| W8" X 18 | W8" X 24 | W10" X 26 | W12" X 30 |
| T0210921 | T0210922 | T0210923 | T0210924 |

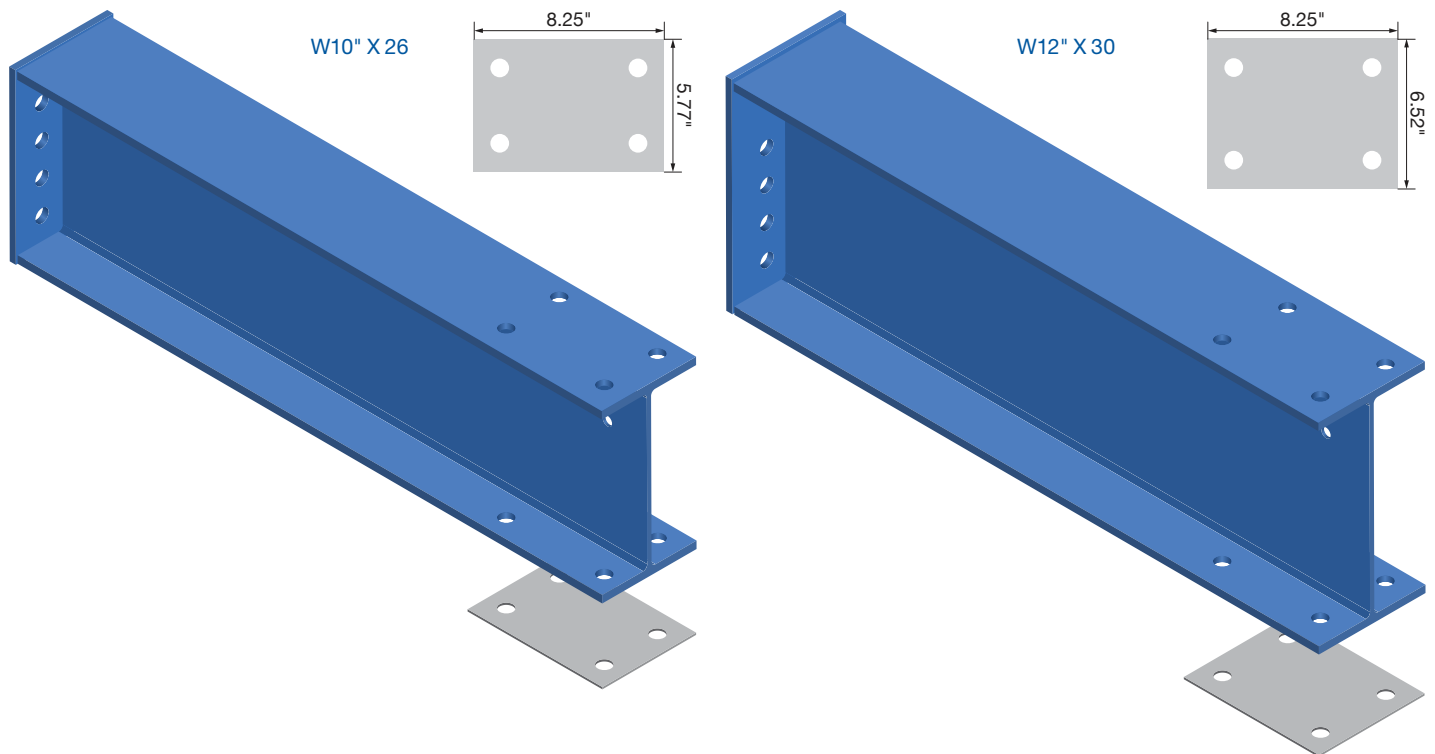

ANCHOR DISTRIBUTION

ANCHOR 3/4 X 5-1/2 HILTI TZ (U0077330)

Every column and base on the H23 Cantilever rack installation should be anchored to the floor using at least one anchor.

Some installations require additional heavier anchorage due to seismic or wind considerations.

The standard anchor provided for H23 Cantilever installations is HILTI TZ Anchor 3/4 X 5-1/2" (U0077330).

STANDARD ANCHOR DISTRIBUTION IN NON-SEISMIC ZONES

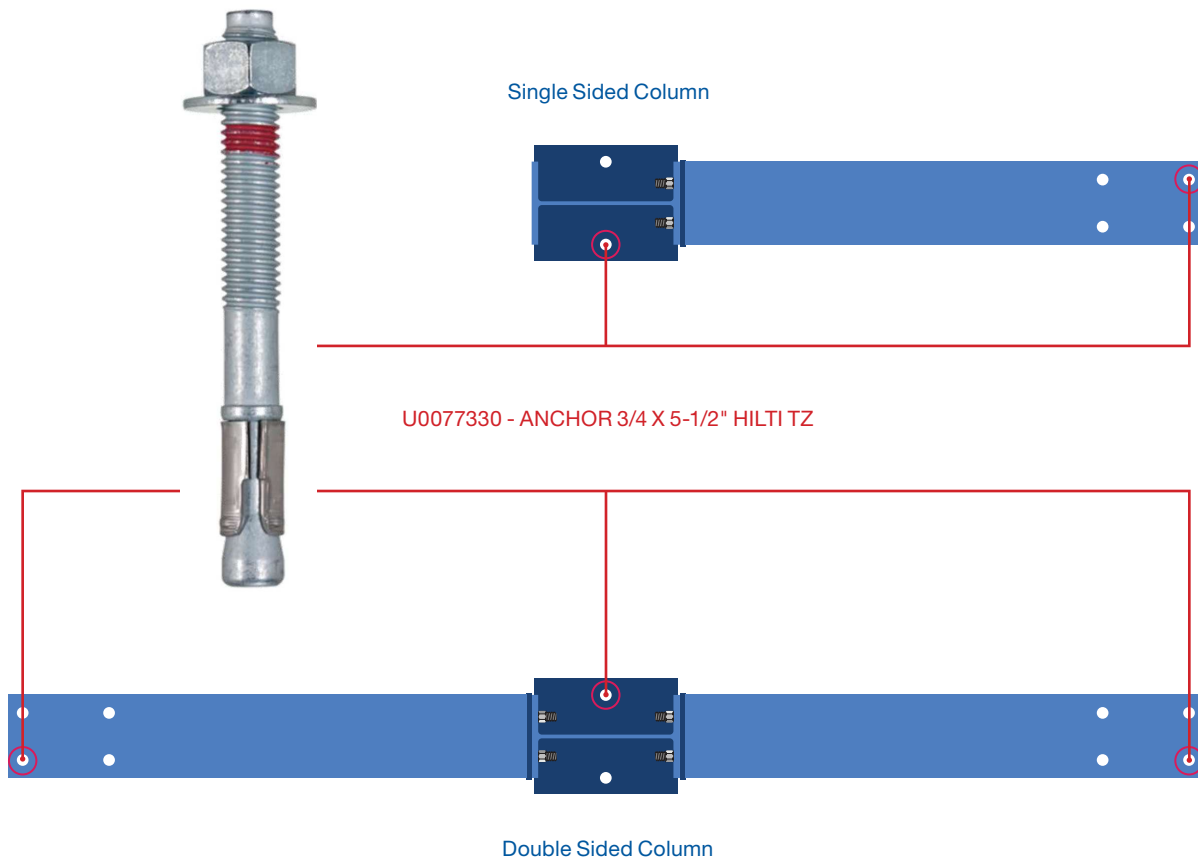

STRUCTURAL CANTILEVER ARMS H23

ARM H23 S3"X5.7U, S4"X7.7U

These arms consist of two pieces starting with profile section S3", S4", S5" or S6", with a connection plate with four holes that will connect the arm to the column using (4) Bolts $\frac{3}{4}$ " X 2" G5 Z (U0074780) and (4) Nuts $\frac{3}{4}$ "-10 G5 Z (U0074695).

- Compatible with H23 Columns: W8"X18, W8"X24, W10"X26 and W12"X30.
- Available in standard Orange finish (RAL 2001).
- Standard lengths are: 24", 36", 48", 60" and 72".

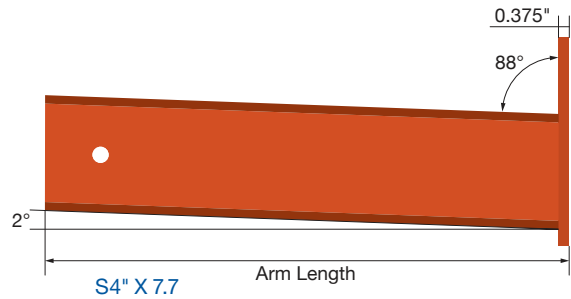
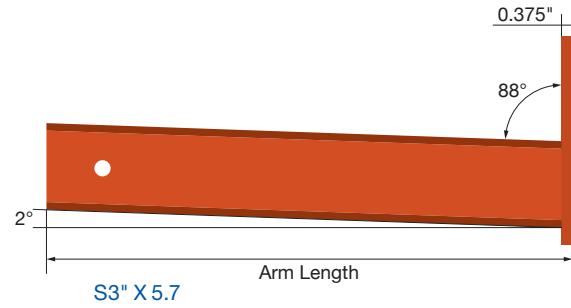
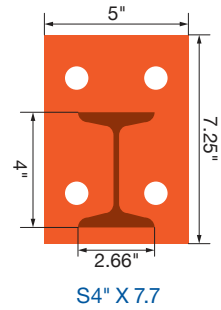
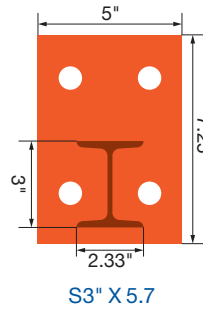

ARMS H23 S3"X 5.7 U 2'

Arm Height: 3", 4", 5" or 6"

Pounds per foot (weight)
3"=5.7, 4"=7.7, 5"=10 and 6"=12.5

Arm Length (ft)

| H23 Arm Part Numbers | | | | |
|----------------------|-----------|-----------|------------|------------|
| Arm Length | S3" X 5.7 | S4" X 7.7 | S5" X 10.0 | S6" X 12.5 |
| 2' | T0210864 | T0210869 | T0210874 | T0210879 |
| 3' | T0210865 | T0210870 | T0210875 | T0210880 |
| 4' | T0210866 | T0210871 | T0210876 | T0210881 |
| 5' | T0210867 | T0210872 | T0210877 | T0210882 |
| 6' | T0210868 | T0210873 | T0210878 | T0210883 |

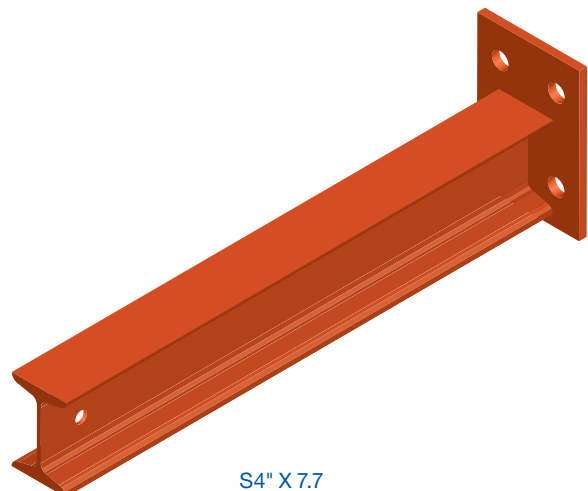
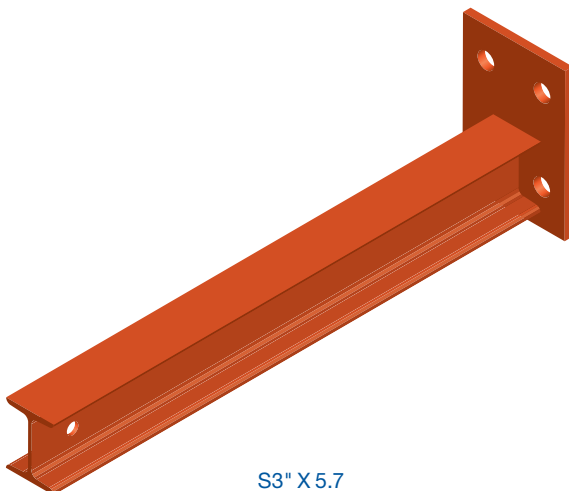

STRUCTURAL CANTILEVER ARMS H23

ARM H23 S5"X10.0U, S6"X12.5U

These arms consist of two pieces starting with profile section S3", S4", S5" or S6", with a connection plate with four holes that will connect the arm to the column using (4) Bolts $\frac{3}{4}$ " X 2" G5 Z (U0074780) and (4) Nuts $\frac{3}{4}$ "-10 G5 Z (U0074695).

- Compatible with Heavy-Duty Columns: W8"X18, W8"X24, W10"X26 and W12"X30.
- Available in standard Orange finish (RAL 2001).
- Standard lengths are: 24", 36", 48", 60" and 72".

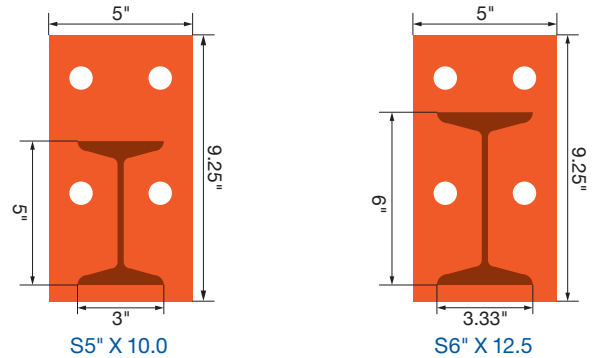

ARMS H23 S5" X 10.0 U 2'

Arm Height: 3", 4", 5" or 6"

Pounds per foot (weight)
3"=5.7, 4"=7.7, 5"=10 and 6"=12.5

Arm Length (ft)

| H23 Arm Part Numbers | | | | |
|----------------------|-----------|-----------|------------|------------|
| Arm Length | S3" X 5.7 | S4" X 7.7 | S5" X 10.0 | S6" X 12.5 |
| 2' | T0210864 | T0210869 | T0210874 | T0210879 |
| 3' | T0210865 | T0210870 | T0210875 | T0210880 |
| 4' | T0210866 | T0210871 | T0210876 | T0210881 |
| 5' | T0210867 | T0210872 | T0210877 | T0210882 |
| 6' | T0210868 | T0210873 | T0210878 | T0210883 |

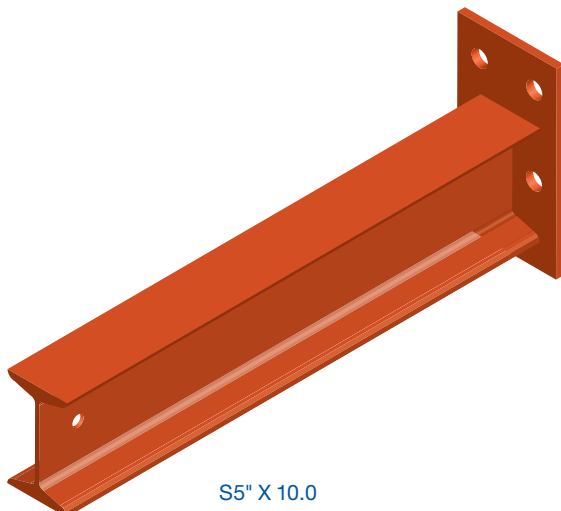
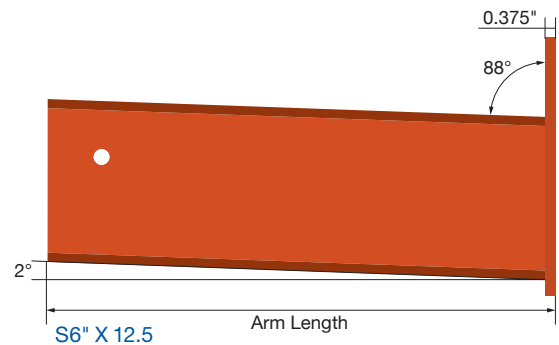
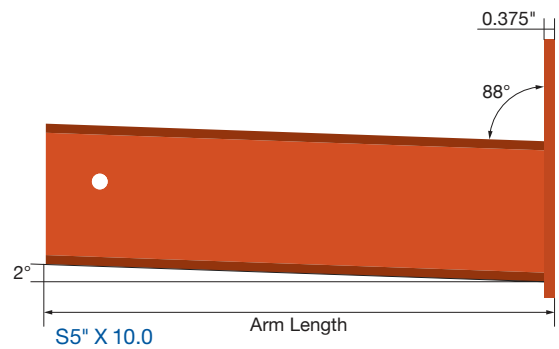

S5" X 10.0

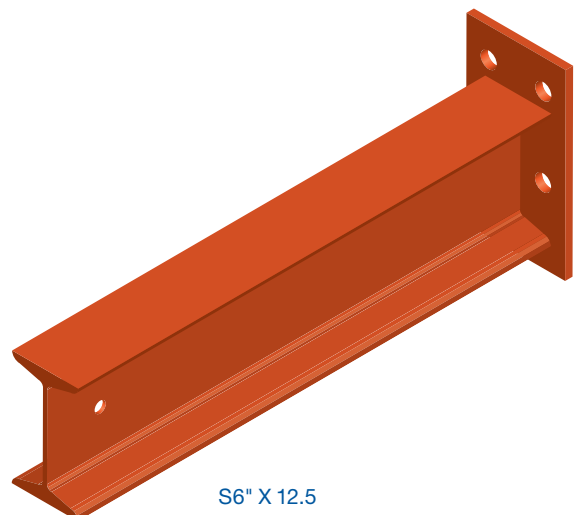

S6" X 12.5

STRUCTURAL CANTILEVER PIPE STOP ASSEMBLY

PIPE SOCKET U H23 - T0210925

The pipe socket serves as a holder for the Stop Mobile Round U H23. The socket can be attached to the arms or base using (1) Bolt $\frac{1}{2}$ -13 X 1 $\frac{1}{2}$ " HHC G5 Z (U0074603) and (1) Nut $\frac{1}{2}$ -13 HEX Z (U0077338).

- Available in standard Blue finish (RAL 5003).

STOP MOBILE ROUND U H23 - T0210926

Metallic cylinder with a 1" diameter and 10" length. Inserted into the Pipe Socket H23 U in order to act as a load stopper.

- Available in standard Blue finish (RAL 5003).

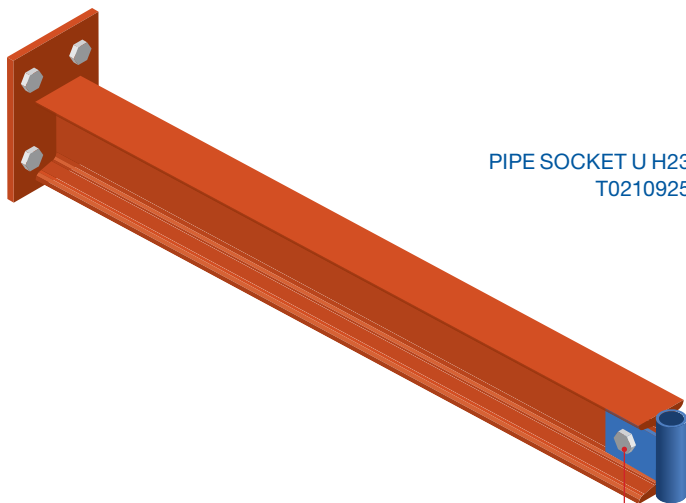
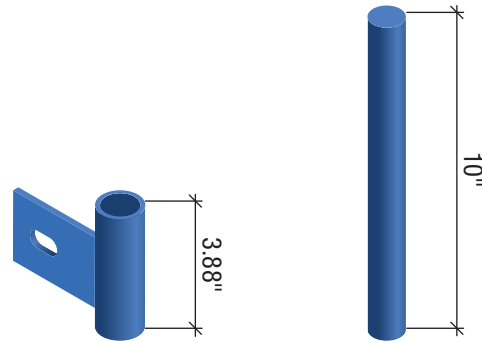

PIPE SOCKET U H23
T0210925

U0074603 - BOLT
U0077338 - NUT

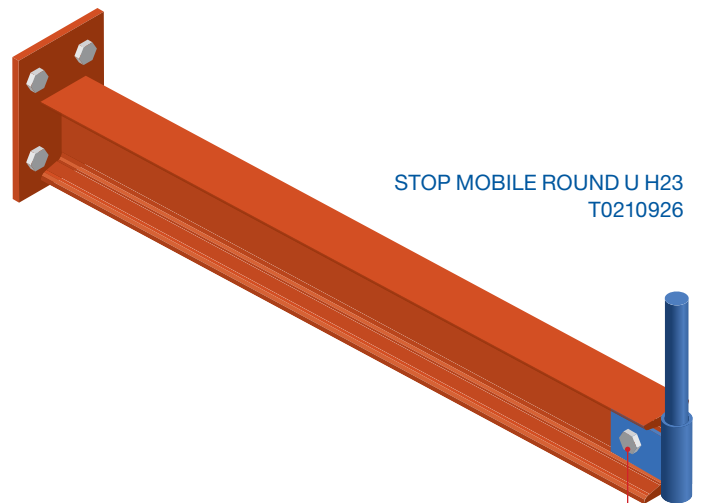

STOP MOBILE ROUND U H23
T0210926

U0074603 - BOLT
U0077338 - NUT

MINIMUM ELEVATIONS

COLUMN W8" X 18

Distance from highest arm level to top of column.

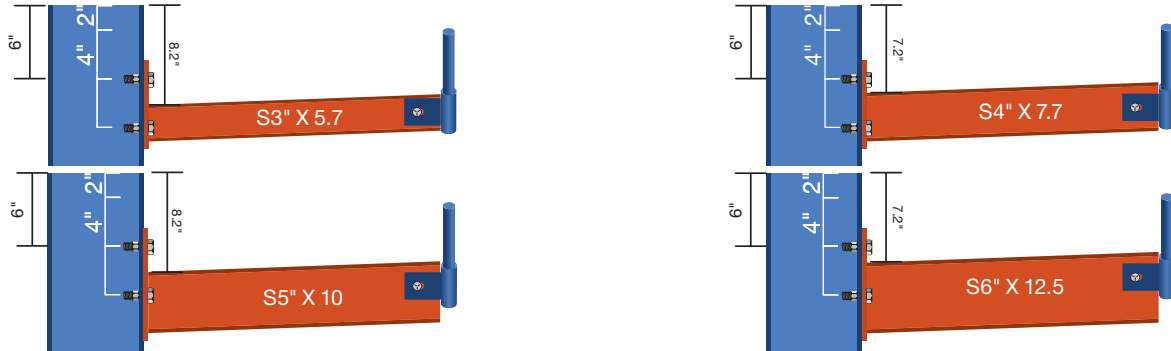

COLUMN W8" X 24

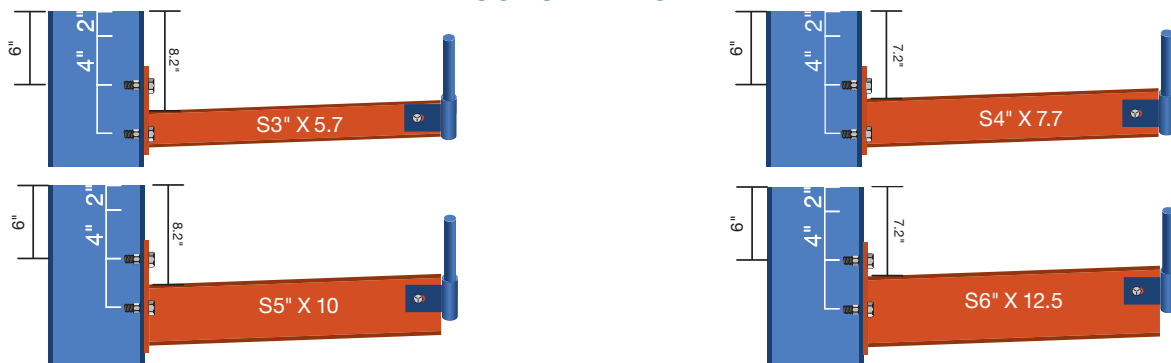

COLUMN W10" X 26

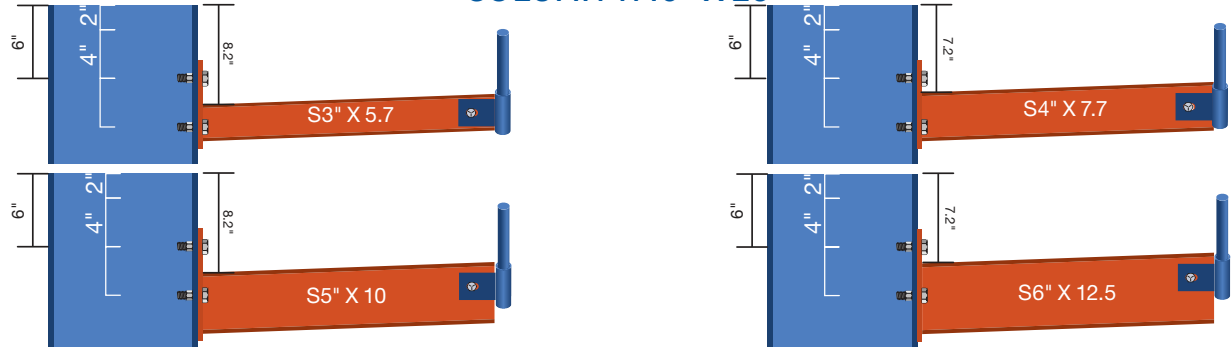

COLUMN W12" X 30

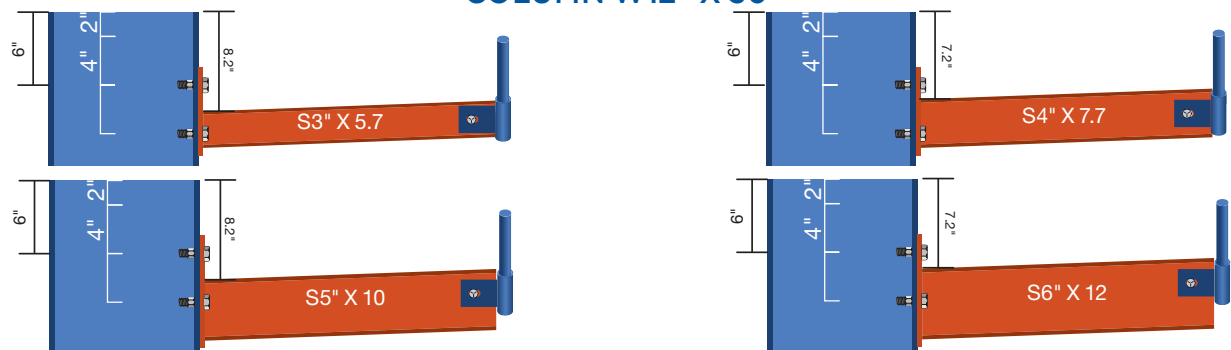

MINIMUM ELEVATIONS

COLUMN W8" X 18

Distance between arms without pipe stop.

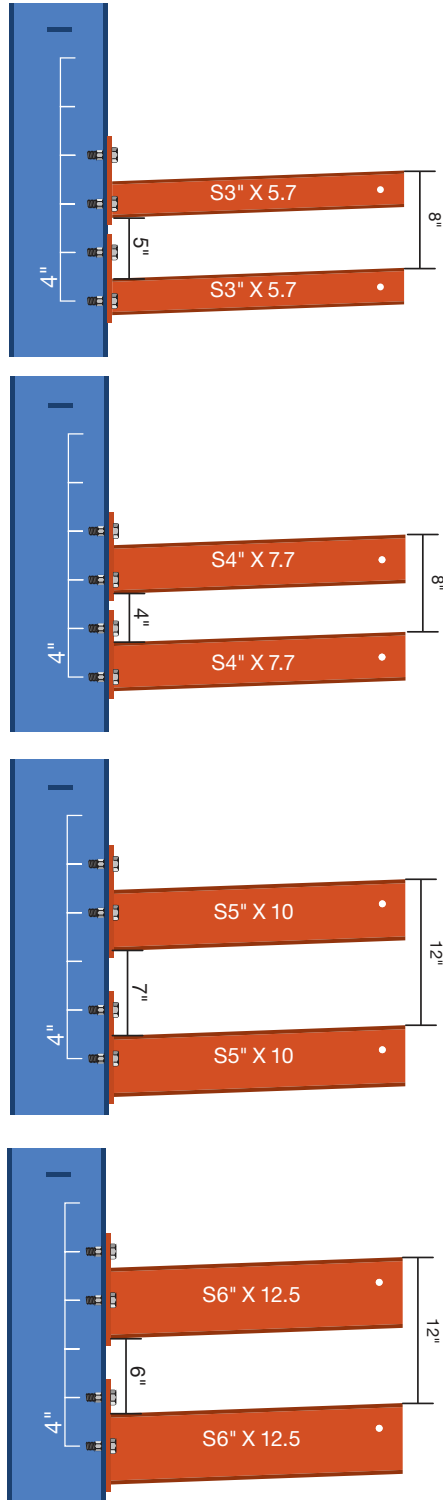

COLUMN W8" X 18

Distance between arms with pipe stop.

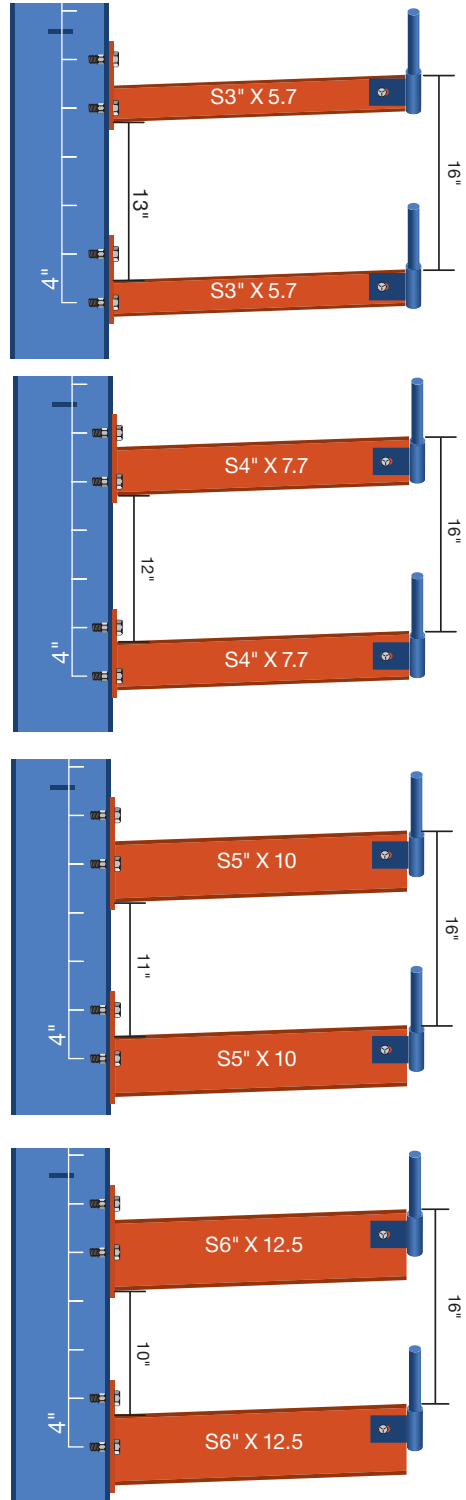

MINIMUM ELEVATIONS

COLUMN W8" X 18

Distance between arms without pipe stop.

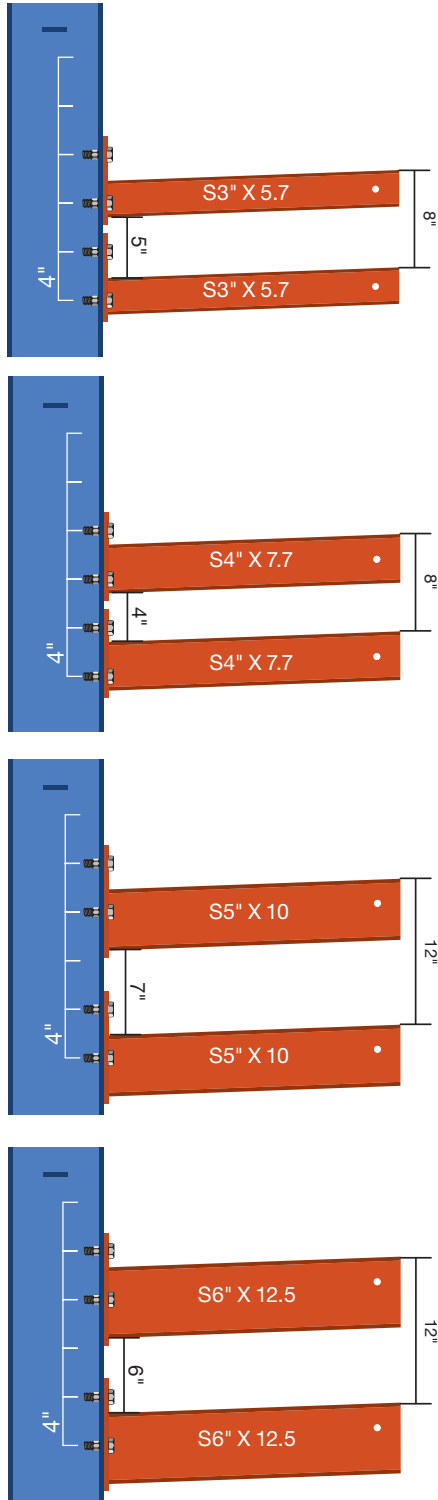

COLUMN W8" X 18

Distance between arms with pipe stop.

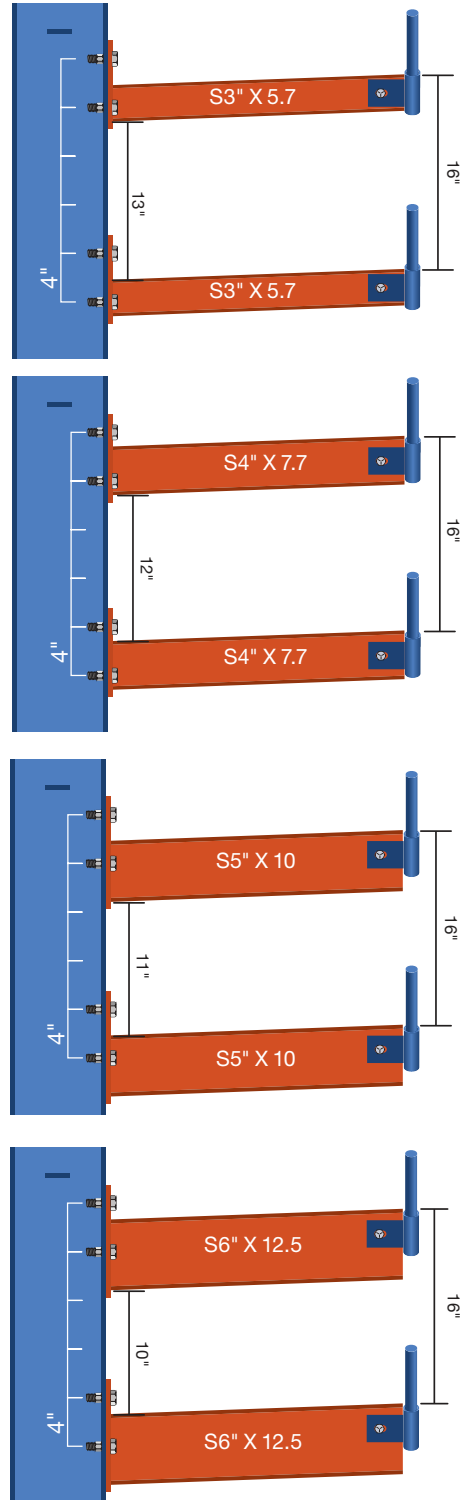

MINIMUM ELEVATIONS

COLUMN W10" X 26

Distance between arms without pipe stop.

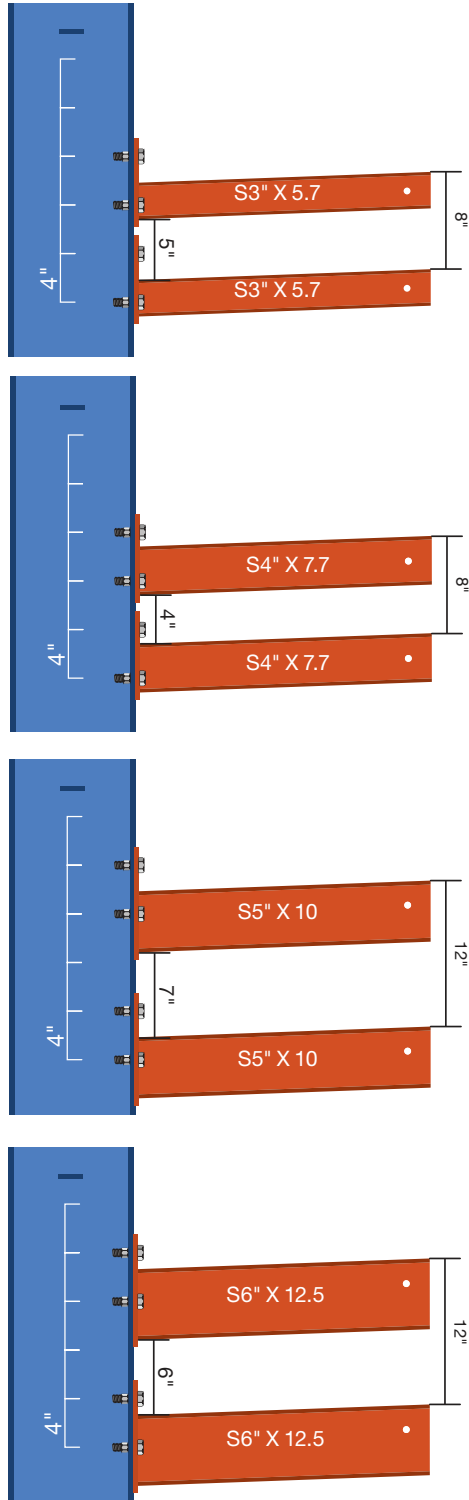

COLUMN W10" X 26

Distance between arms with pipe stop.

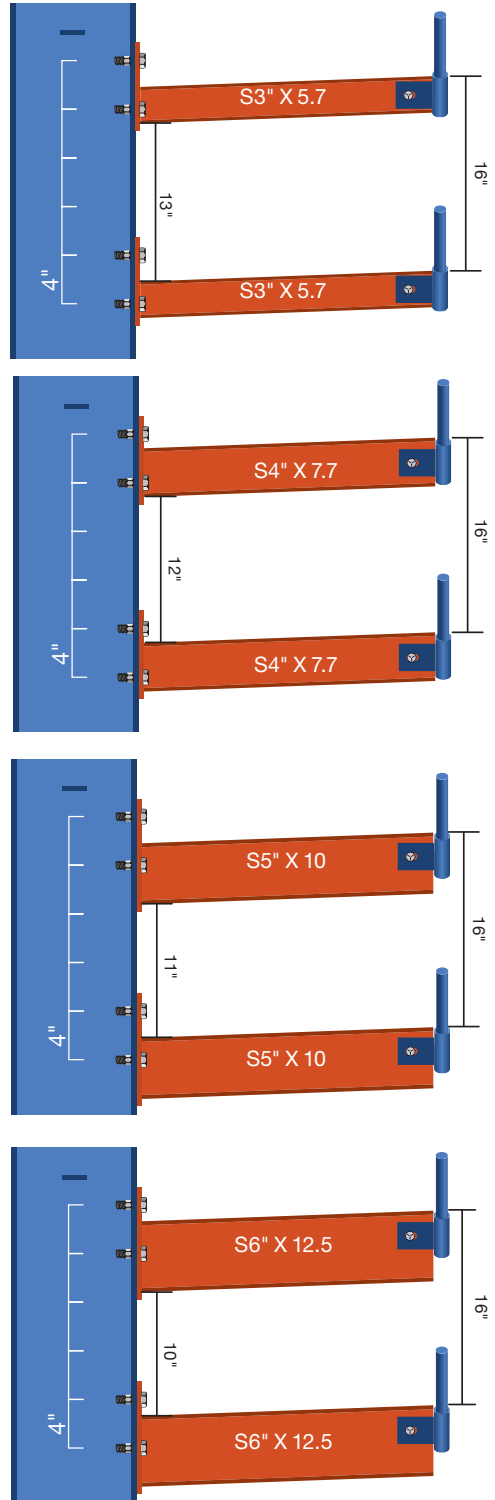

MINIMUM ELEVATIONS

COLUMN W12" X 30

Distance between arms without pipe stop.

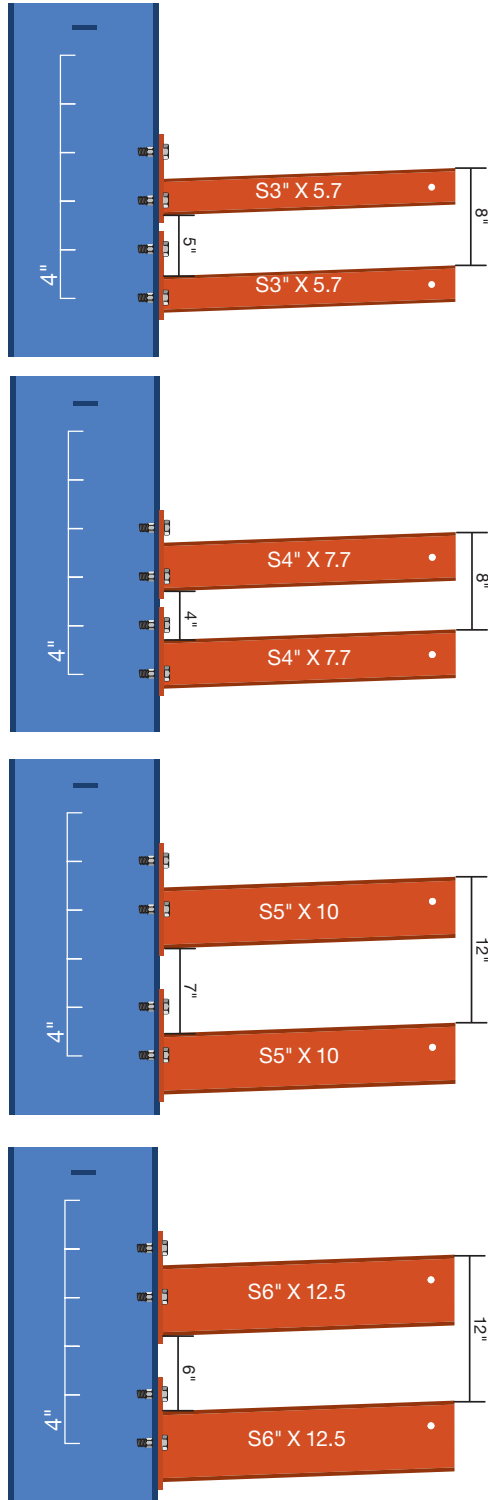

COLUMN W12" X 30

Distance between arms with pipe stop.

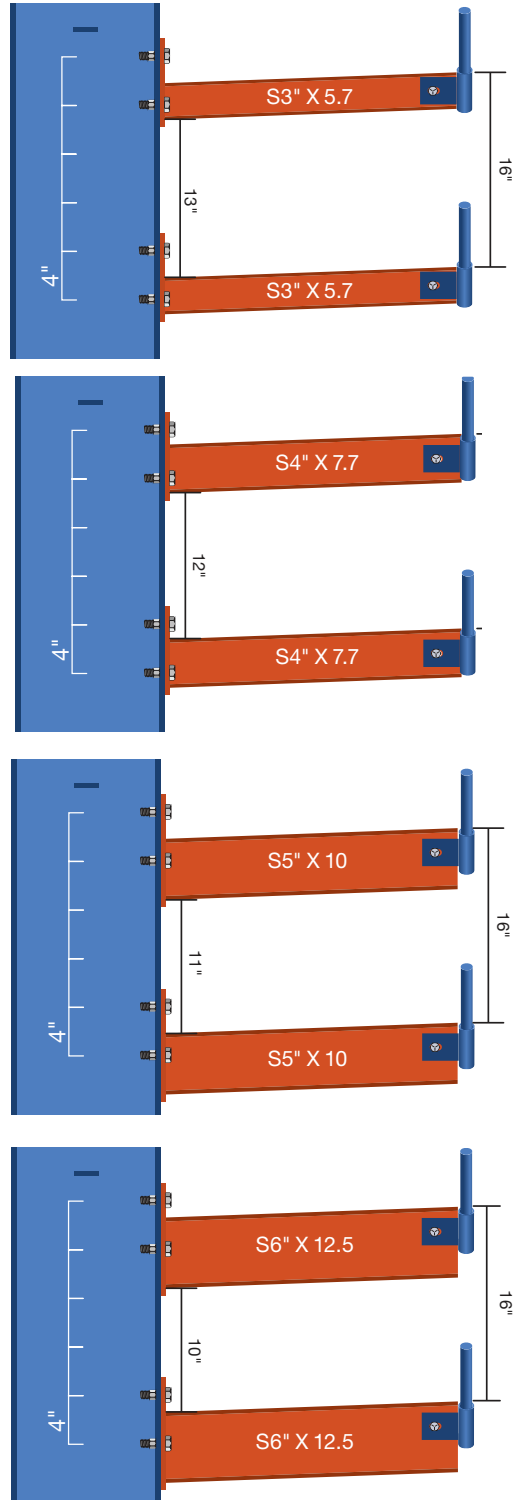

MINIMUM ELEVATIONS

COLUMN W8" X 18

Distance from floor to first arm without pipe stop.

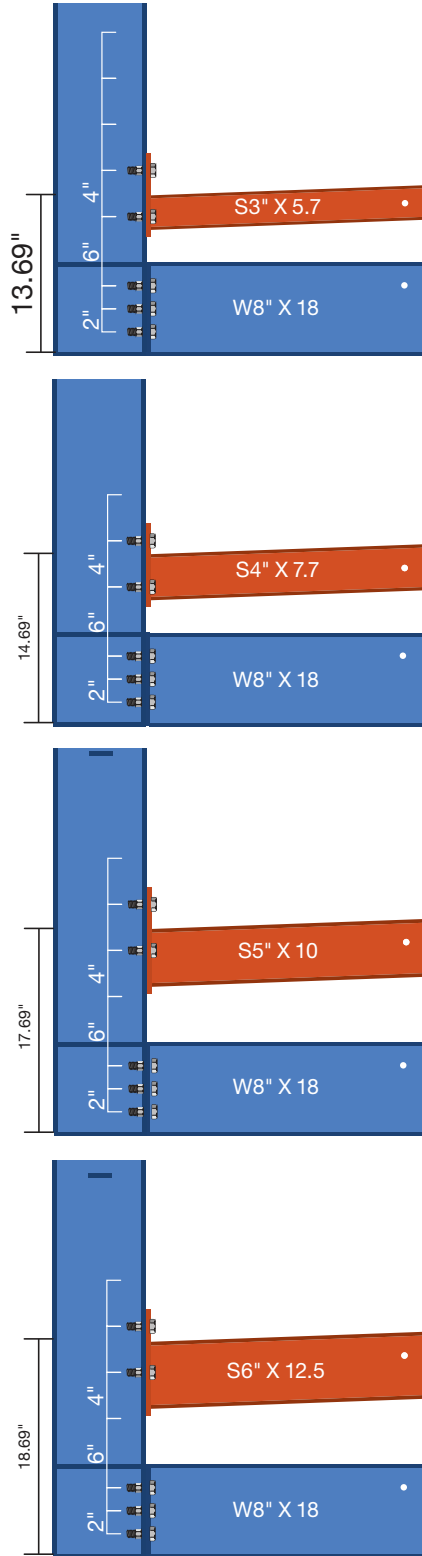

COLUMN W8" X 18

Distance from floor to first arm with pipe stop.

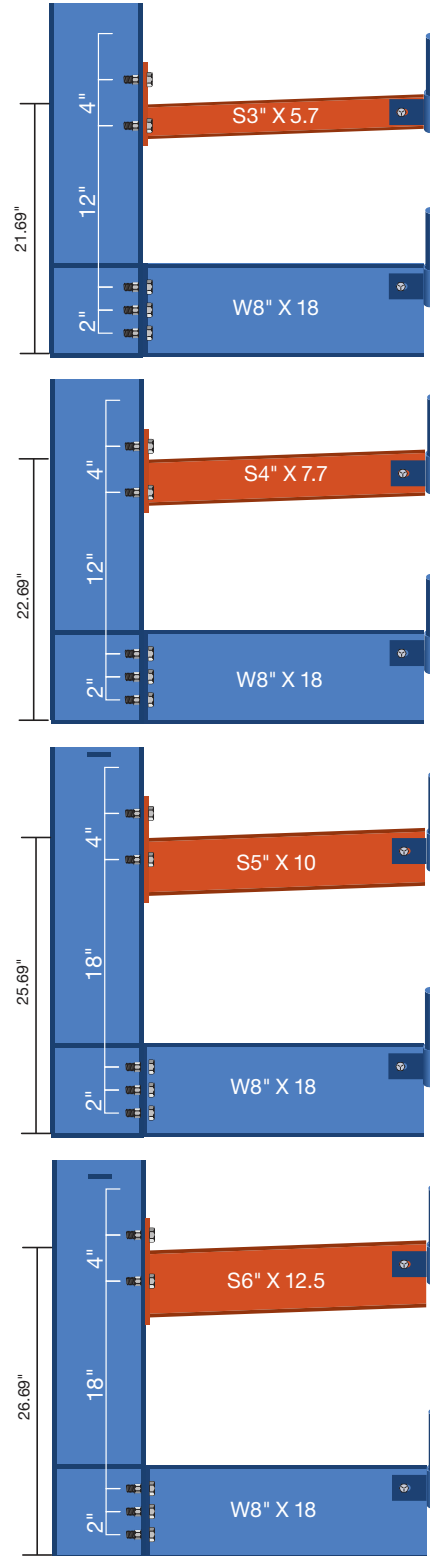

MINIMUM ELEVATIONS

COLUMN W8" X 24

Distance from floor to first arm without pipe stop.

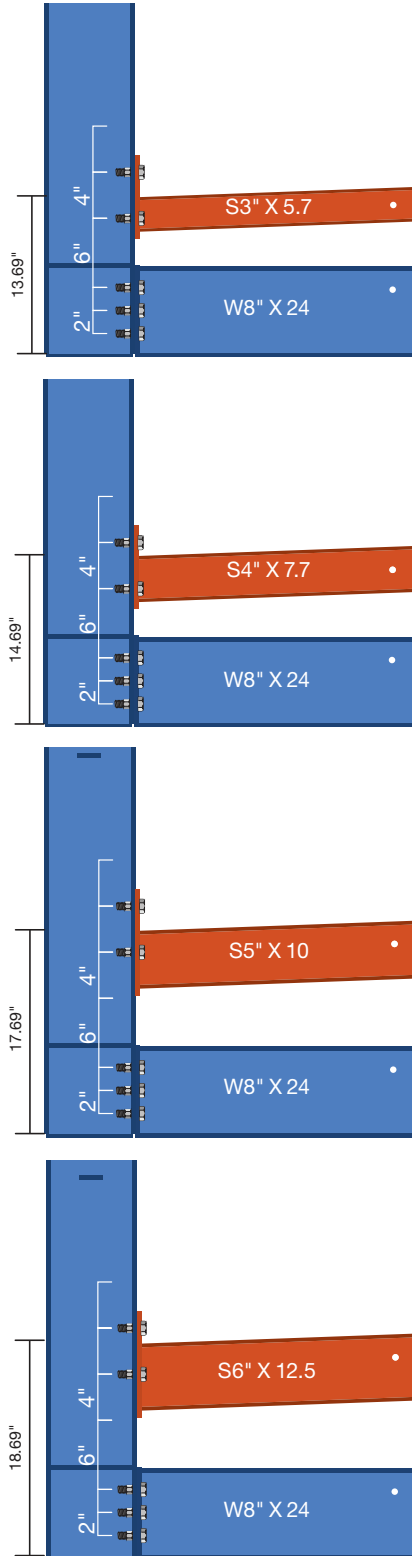

COLUMN W8" X 24

Distance from floor to first arm with pipe stop.

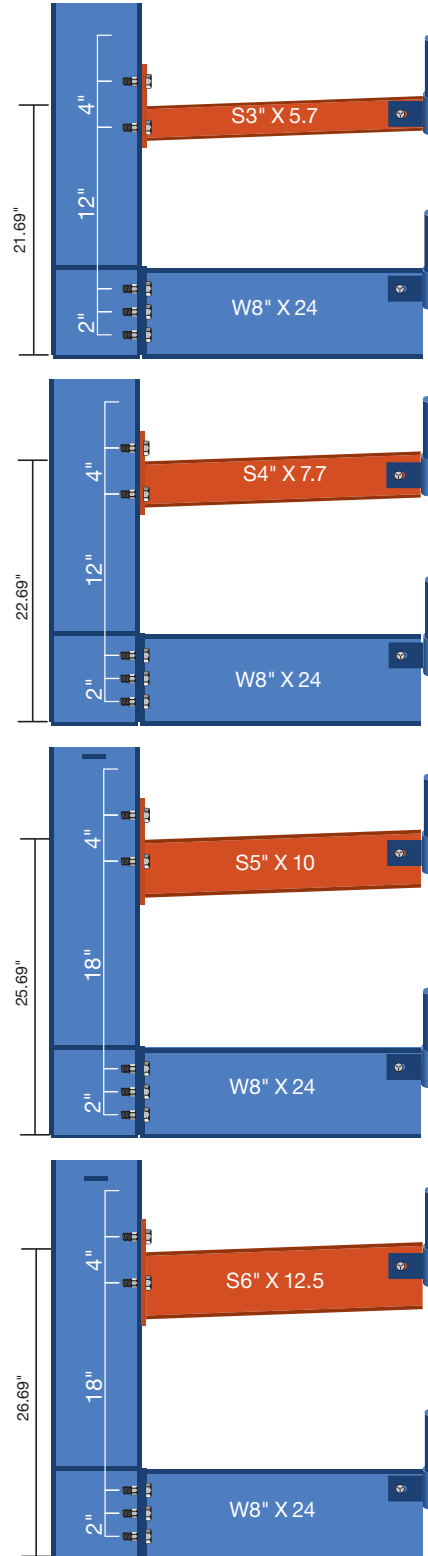

MINIMUM ELEVATIONS

COLUMN W10" X 26

Distance from floor to first arm without pipe stop.

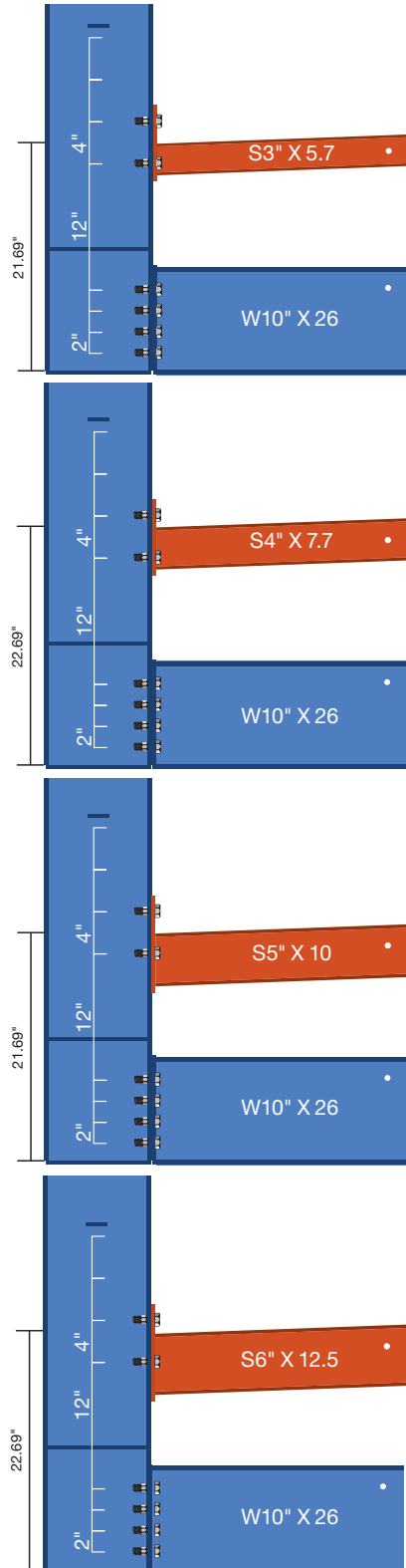

COLUMN W10" X 26

Distance from floor to first arm with pipe stop.

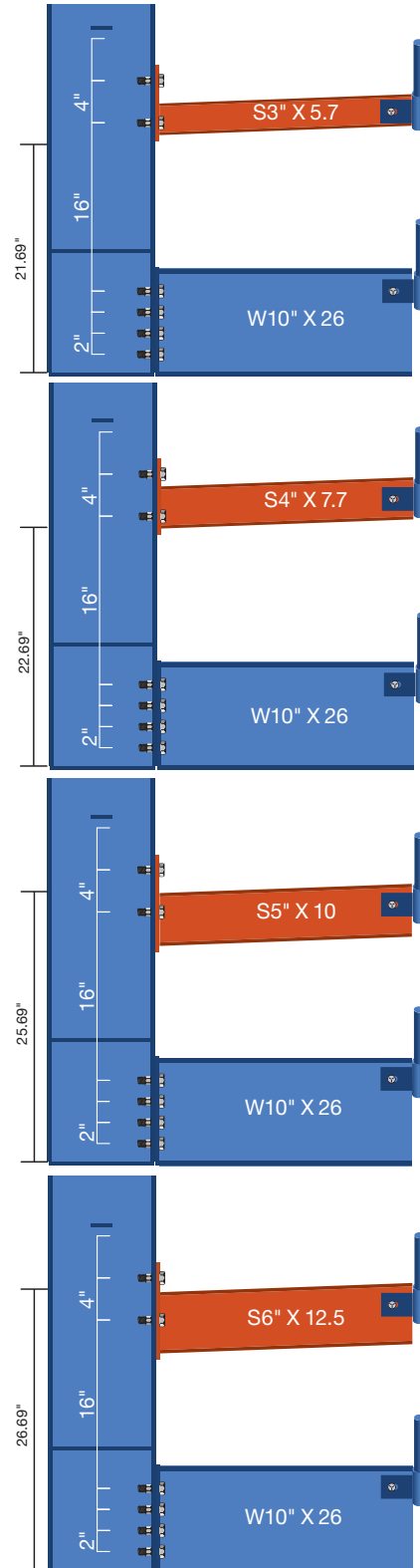

MINIMUM ELEVATIONS

COLUMN W12" X 30

Distance from floor to first arm without pipe stop.

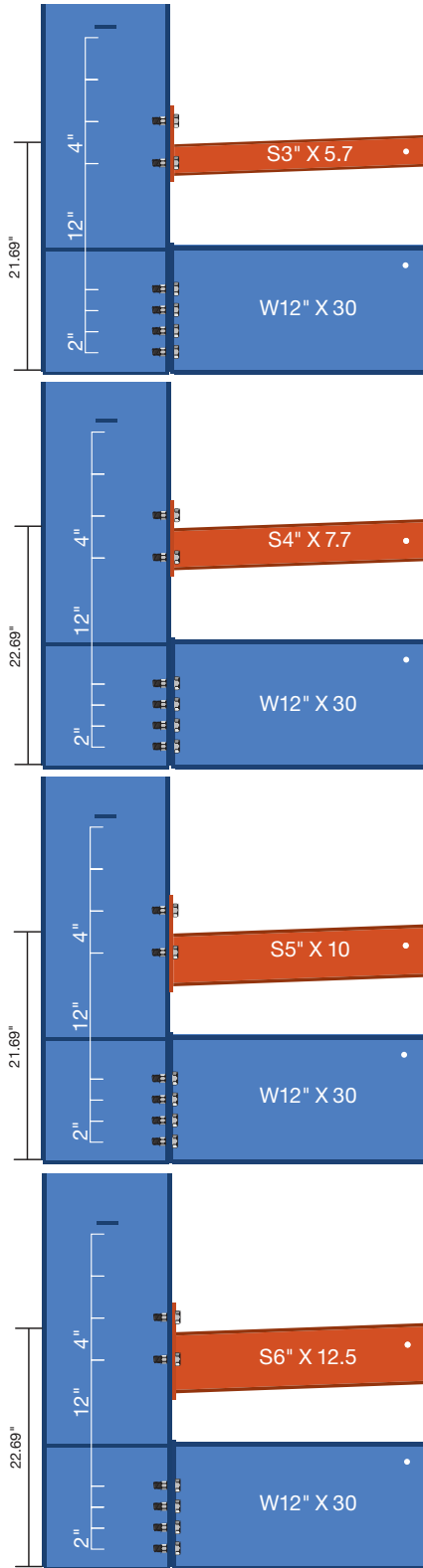

COLUMN W12" X 30

Distance from floor to first arm with pipe stop.

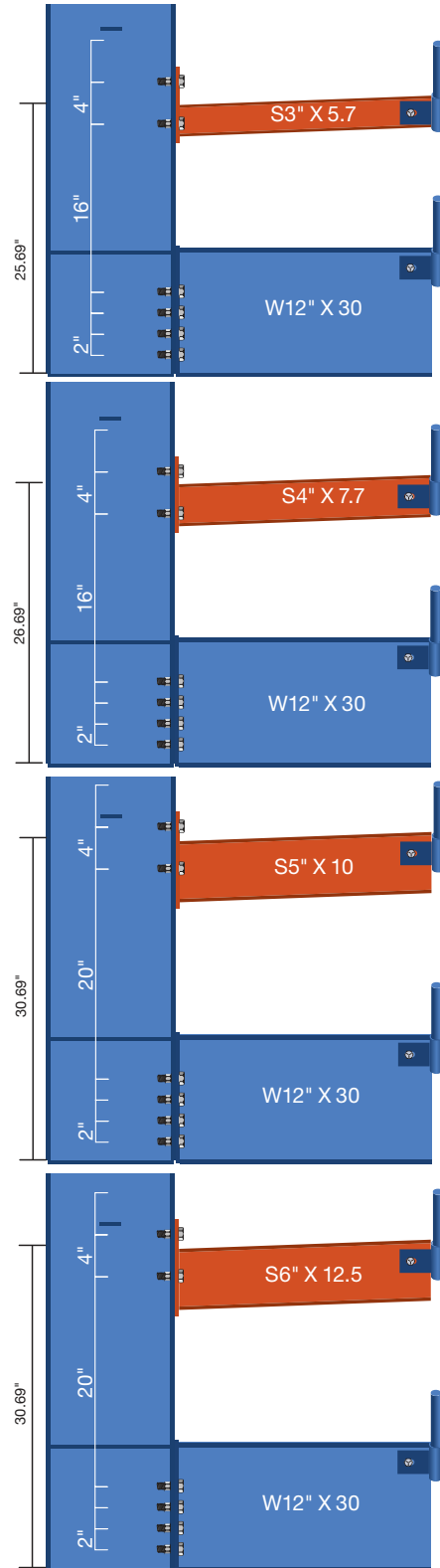

HORIZONTAL BRACING

WELDED BRACING CLIPS

Welded bracing clips are used to connect the Horizontal Bracing into the H23 Cantilever columns. The first plate is welded at a height of 48" (except for the 8' column, where it is welded at 33"), subsequently the plates will be welded to the column every 60".

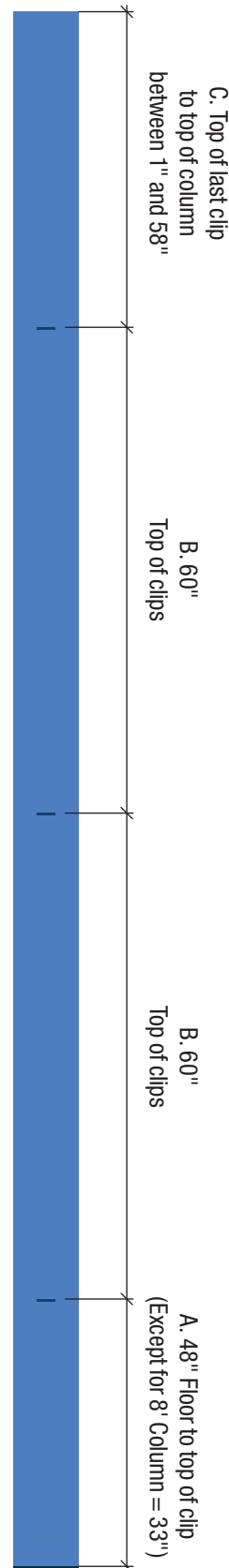
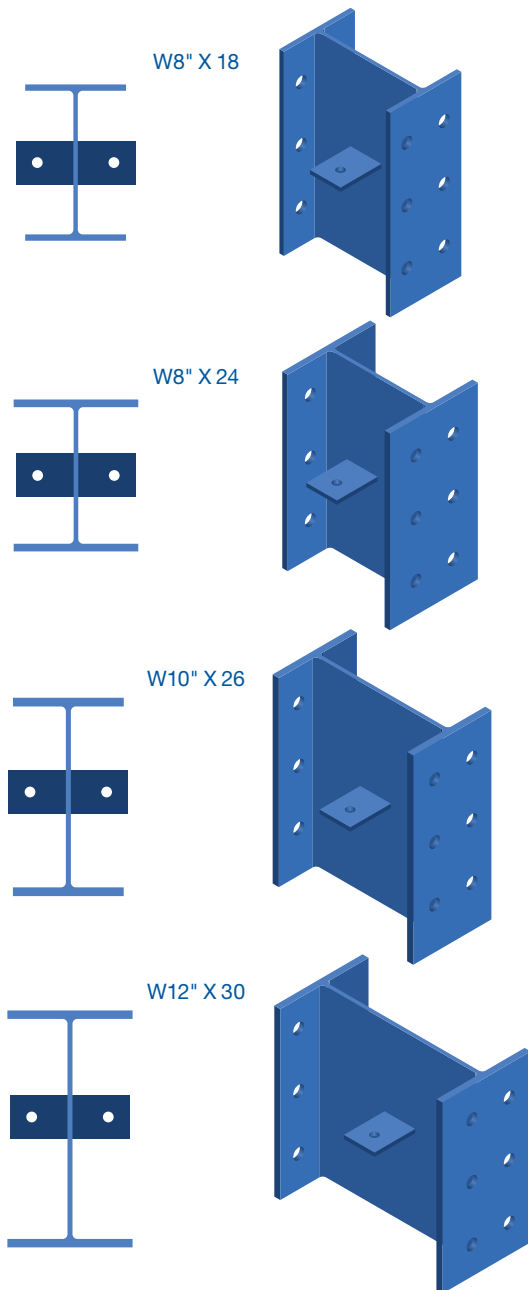

| BRACING CLIP DISTANCES | | | | |
|------------------------|--------------|-----|-----|-----|
| Column Height | No. of clips | A | B | C |
| 8' (96") | 2 | 33" | 60" | 1" |
| 10' (120") | 2 | 48" | 60" | 10" |
| 12' (144") | 2 | 48" | 60" | 34" |
| 14' (168") | 2 | 48" | 60" | 58" |
| 16' (192") | 3 | 48" | 60" | 22" |
| 18' (216") | 3 | 48" | 60" | 46" |
| 20' (240") | 4 | 48" | 60" | 6" |
| 22' (264") | 4 | 48" | 60" | 34" |
| 24' (288") | 4 | 48" | 60" | 58" |
| 26' (312") | 5 | 48" | 60" | 22" |
| 28' (336") | 5 | 48" | 60" | 46" |
| 30' (360") | 6 | 48" | 60" | 10" |
| 32' (384") | 6 | 48" | 60" | 34" |
| 34' (408") | 6 | 48" | 60" | 58" |
| 36' (432") | 7 | 48" | 60" | 22" |
| 38' (456") | 7 | 48" | 60" | 46" |

HORIZONTAL BRACING

HORIZONTAL U L 2X2X3/16

Horizontal brace for H23 Cantilever

Available in standard Mecalux Blue finish (RAL 5003).

Connects to the H23 bracing clips using:

(2) Bolts 1/2 X 1 5/8" D933 G5 B T.2A (T0058504).

| HORIZONTAL U L 2 X 2 X 3/16 Part Numbers | | |
|--|------------------|-------------|
| Length | Center to Center | Part Number |
| 22" | 24" | T0210895 |
| 28" | 30" | T0210896 |
| 34" | 36" | T0210897 |
| 40" | 42" | T0210898 |
| 46" | 48" | T0210899 |
| 52" | 54" | T0210900 |
| 58" | 60" | T0210901 |
| 64" | 66" | T0210902 |
| 70" | 72" | T0210903 |
| 82" | 84" | T0210904 |
| 94" | 96" | T0210905 |

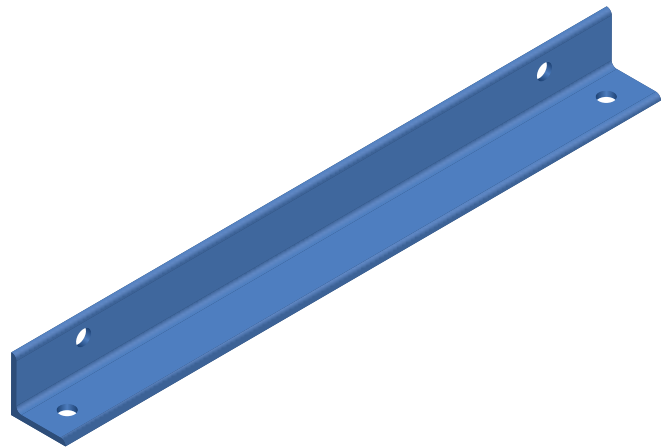
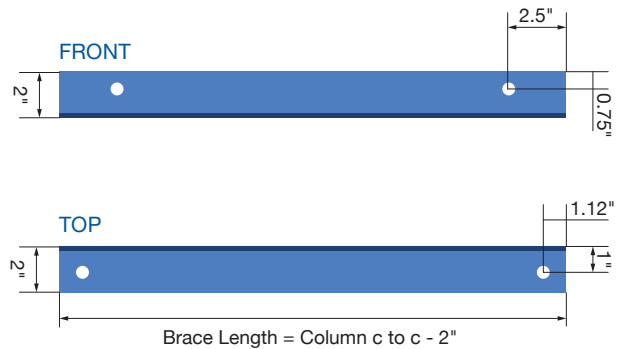

| BRACING REQUIREMENTS | | |
|-----------------------|---------------------------|--------------------|
| Column Height | Horizontal braces per bay | "X" braces per bay |
| 8', 10', and 12' | 2 | 1 |
| 16' | 3 | 1 |
| 18', 20', 22' and 24' | 4 | 2 |
| 26', 28', 30' and 32' | 6 | 3 |
| 34', 36' and 38' | 8 | 4 |

DIAGONAL BRACING

DIAGONAL U BRA.1-1/2 X 1/8

Diagonal brace for H23 Cantilever.

Available in standard Mecalux Blue finish (RAL 5003).

Connects to the H23 Horizontal U L Braces using:

(2) Bolts $1/2 \times 1\ 3/16$ " D933 G5 B T.2A (T0032936).

| DIAGONAL U BRA.1-1/2 X 1/8 Part Numbers | | |
|---|------------------|-------------|
| Length | Center to Center | Part Number |
| 61 $7/32$ " (61.22") | 24" | T0210884 |
| 63 $3/16$ " (63.18") | 30" | T0210885 |
| 65 $11/16$ " (65.68") | 36" | T0210886 |
| 68 $19/32$ " (68.59") | 42" | T0210887 |
| 71 $29/32$ " (71.90") | 48" | T0210888 |
| 75 $9/16$ " (75.56") | 54" | T0210889 |
| 79 $17/32$ " (79.53") | 60" | T0210890 |
| 83 $23/32$ " (83.71") | 66" | T0210891 |
| 88 $1/8$ " (88.12") | 72" | T0210892 |
| 97 $17/32$ " (97.53") | 84" | T0210893 |
| 107 $11/32$ " (107.34") | 96" | T0210894 |

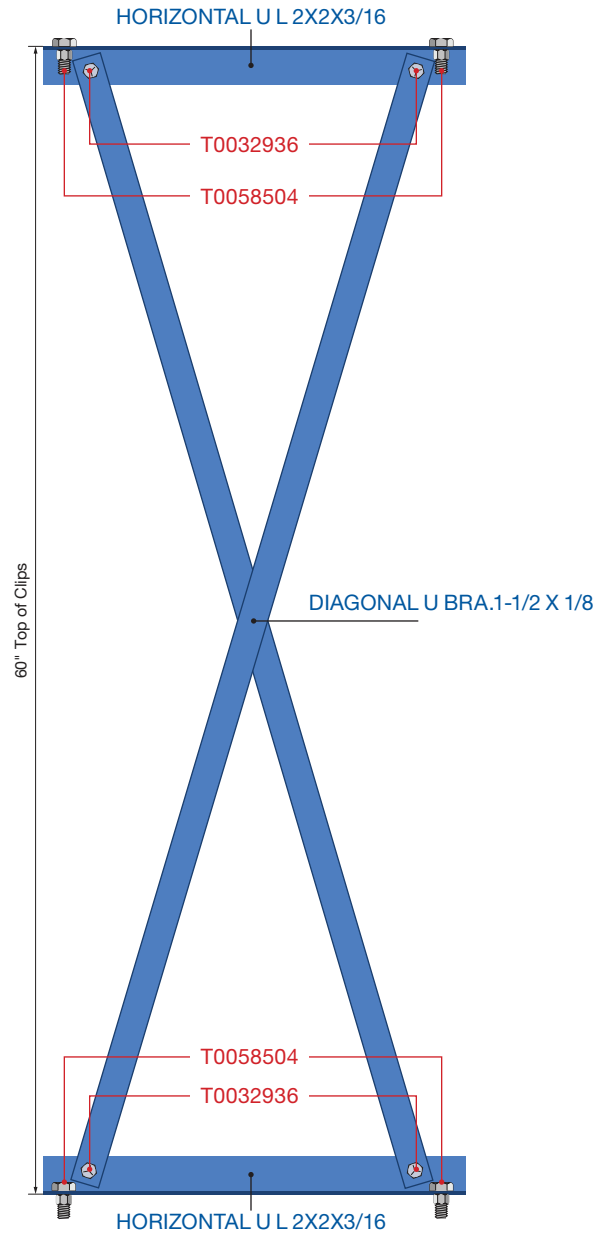

| BRACING REQUIREMENTS | | |
|-----------------------|---------------------------|--------------------|
| Column Height | Horizontal braces per bay | "X" braces per bay |
| 8', 10', and 12' | 2 | 1 |
| 16' | 3 | 1 |
| 18', 20', 22' and 24' | 4 | 2 |
| 26', 28', 30' and 32' | 6 | 3 |
| 34', 36' and 38' | 8 | 4 |

UPPER BRACING

UPPER HORIZ. U L 2X2X3/16

Horizontal brace for the top level of H23 Cantilever.

Available in standard Mecalux Blue finish (RAL 5003).

Connects to the H23 column using:

(2) Bolts 1/2 X 1 3/16" D933 G5 B T.2A (T0032936).

| UPPER HORIZ. U L 2 X 2 X 3/16 Part Numbers | | |
|--|------------------|-------------|
| Length | Center to Center | Part Number |
| 22 3/4" (22.75") | 24" | T0210906 |
| 28 3/4" (28.75") | 30" | T0210907 |
| 34 3/4" (34.75") | 36" | T0210908 |
| 40 3/4" (40.75") | 42" | T0210909 |
| 46 3/4" (46.75") | 48" | T0210910 |
| 52 3/4" (52.75") | 54" | T0210911 |
| 58 3/4" (58.75") | 60" | T0210912 |
| 64 3/4" (64.75") | 66" | T0210913 |
| 70 3/4" (70.75") | 72" | T0210914 |
| 82 3/4" (82.75") | 84" | T0210915 |
| 94 3/4" (94.75") | 96" | T0210916 |

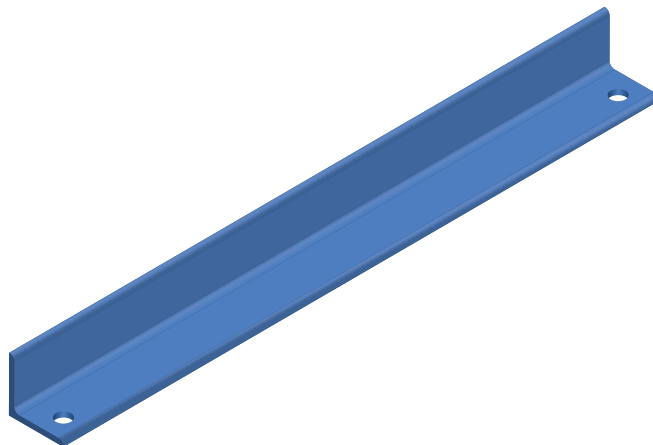
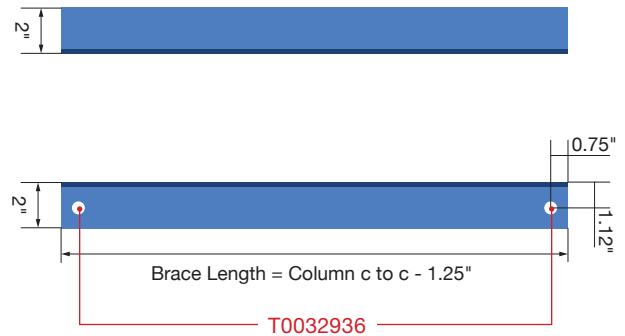

UPPER HORIZ. U L 2X2X3/16

BRACING REQUIREMENTS

Horizontal brace for the top level of H23 Cantilever.

When connected to "L" Single sided columns, only 1 Upper Horizontal is required per bay, however, if "C" Double sided columns are to be used, 2 Upper Horizontal braces are required per bay.

SINGLE SIDED "L" COLUMNS
1 - UPPER HORIZONTAL PER BAY

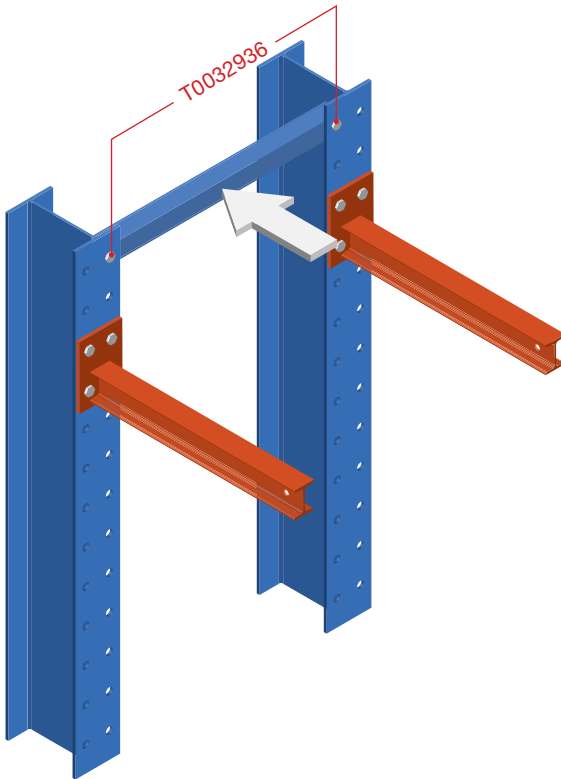

DOUBLE SIDED "C" COLUMNS
2 - UPPER HORIZONTAL PER BAY

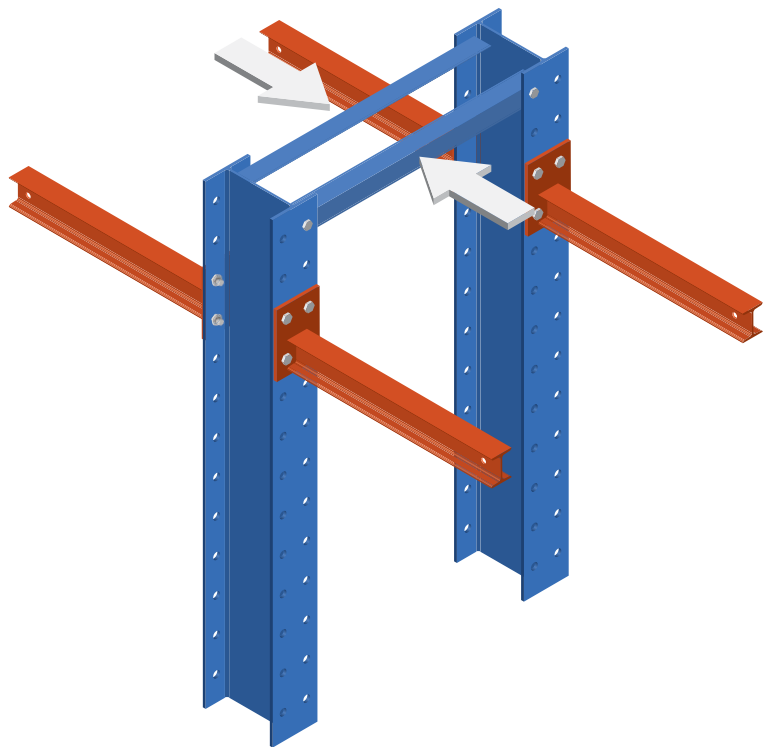

H23 BRACING SCHEMATICS

8' (96") COLUMNS

H23 cantilever rows will have alternating "X" braces starting from the first bay.
When the number of bays is even then there will be 2 bays with "X" bracing at the end of the row.

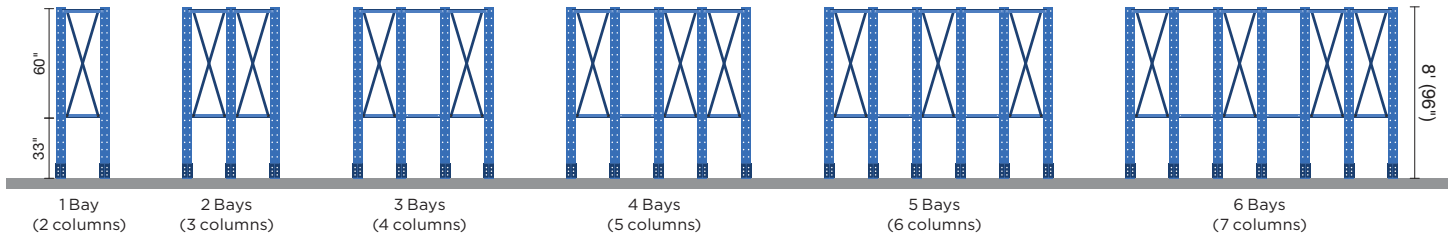

10' (120") COLUMNS

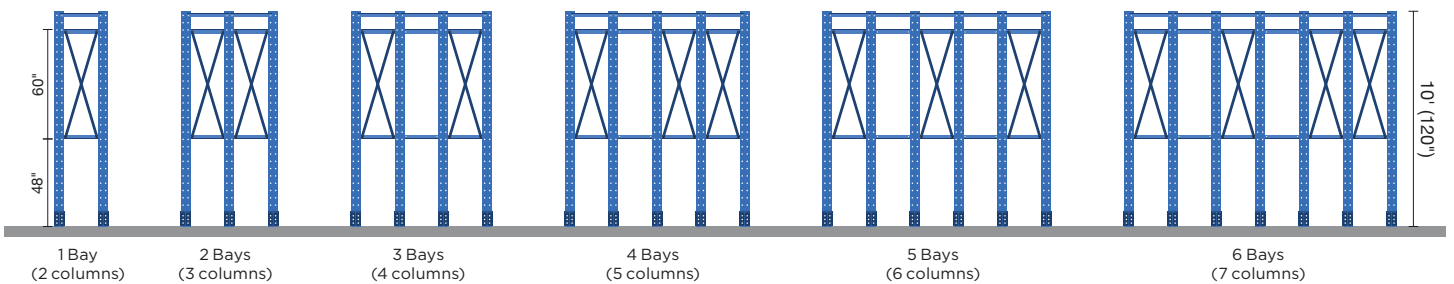

12' (144") COLUMNS

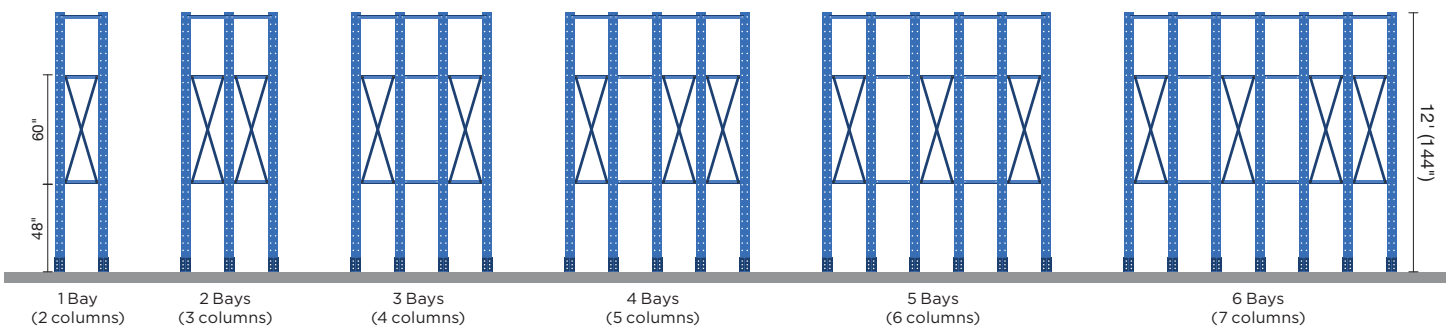

H23 BRACING SCHEMATICS

14' (168") COLUMNS

H23 cantilever rows will have alternating "X" braces starting from the first bay.
When the number of bays is even then there will be 2 bays with "X" bracing at the end of the row.

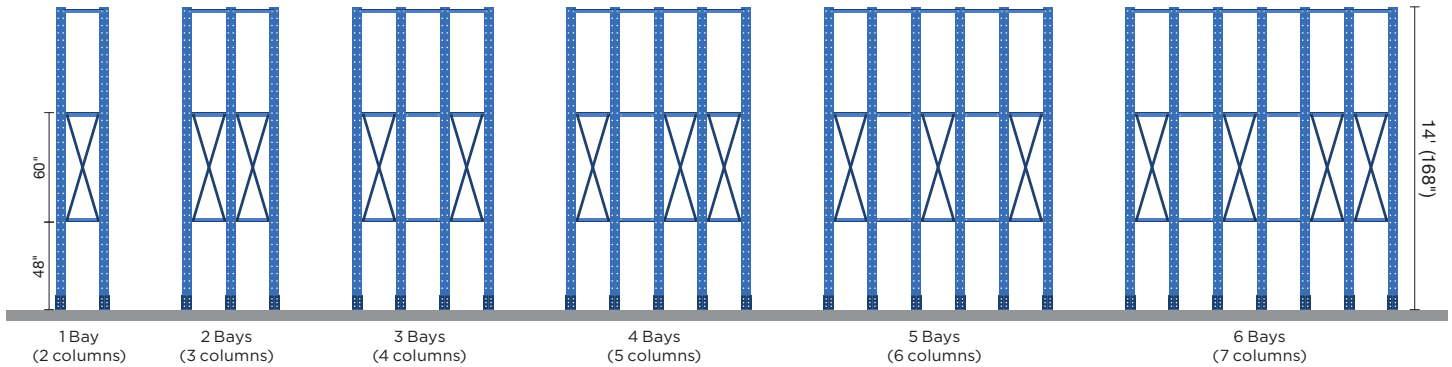

16' (192") COLUMNS

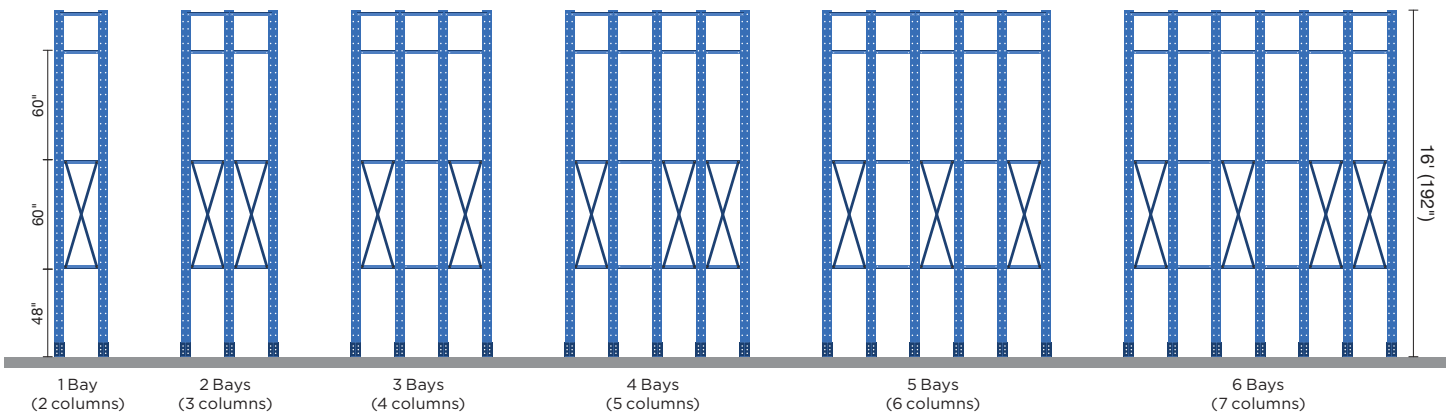

18' (216") COLUMNS

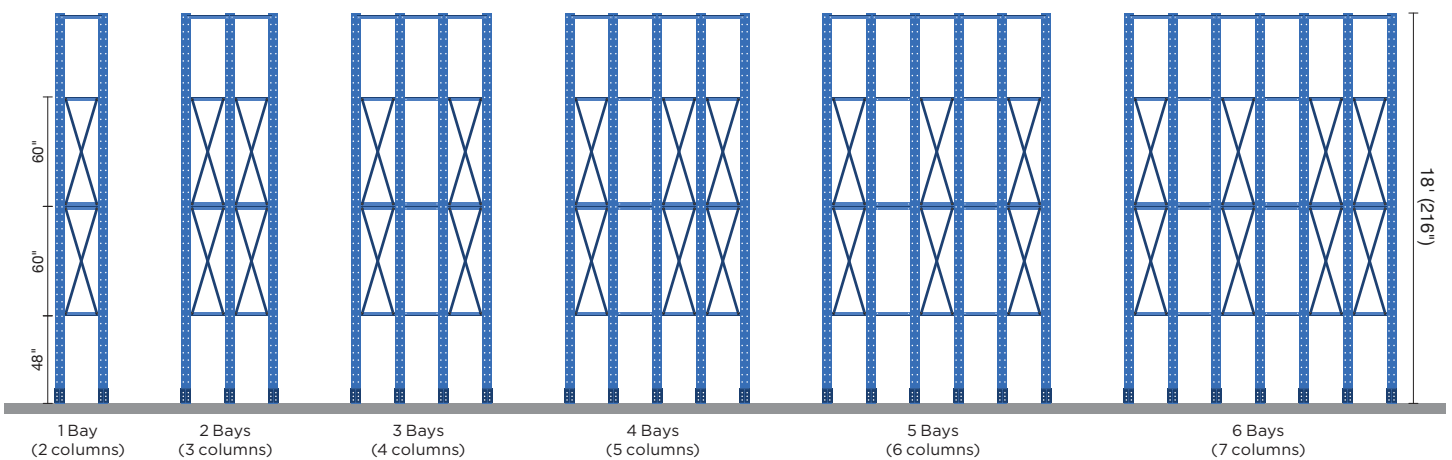

H23 BRACING SCHEMATICS

20' (240") COLUMNS

H23 cantilever rows will have alternating "X" braces starting from the first bay.
When the number of bays is even then there will be 2 bays with "X" bracing at the end of the row.

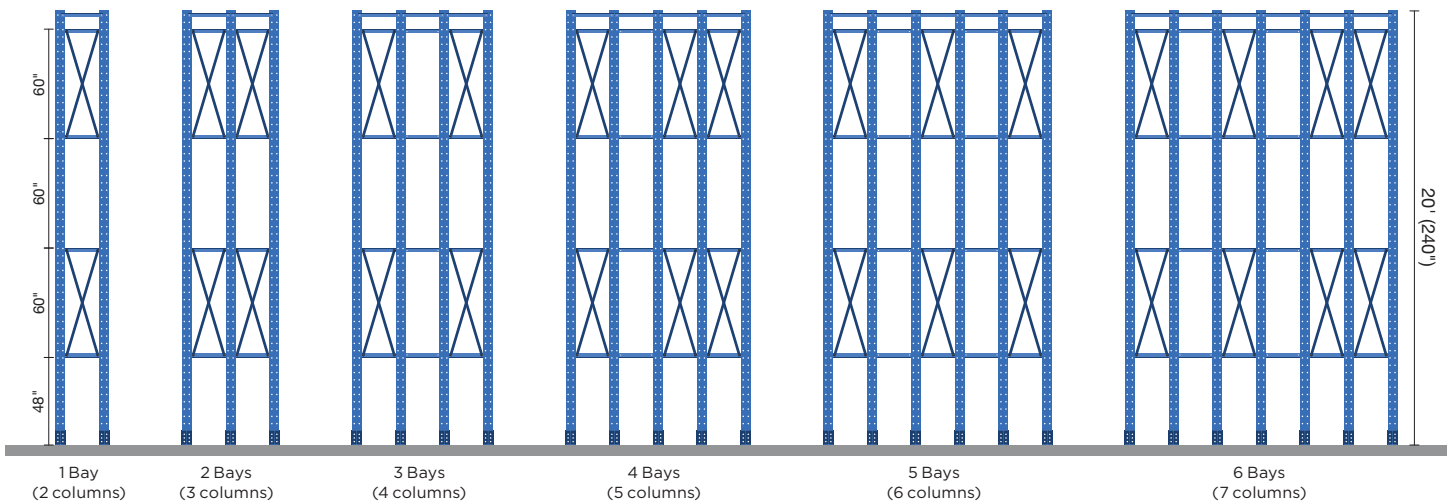

22' (264") COLUMNS

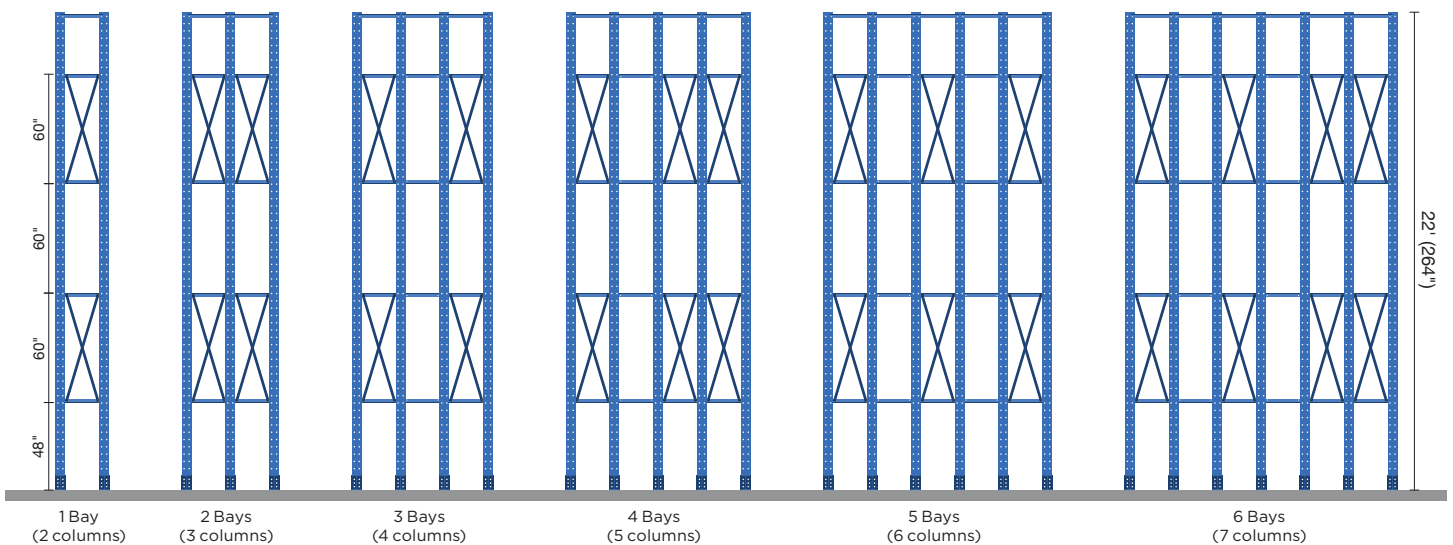

H23 BRACING SCHEMATICS

24' (288") COLUMNS

H23 cantilever rows will have alternating "X" braces starting from the first bay.
When the number of bays is even then there will be 2 bays with "X" bracing at the end of the row.

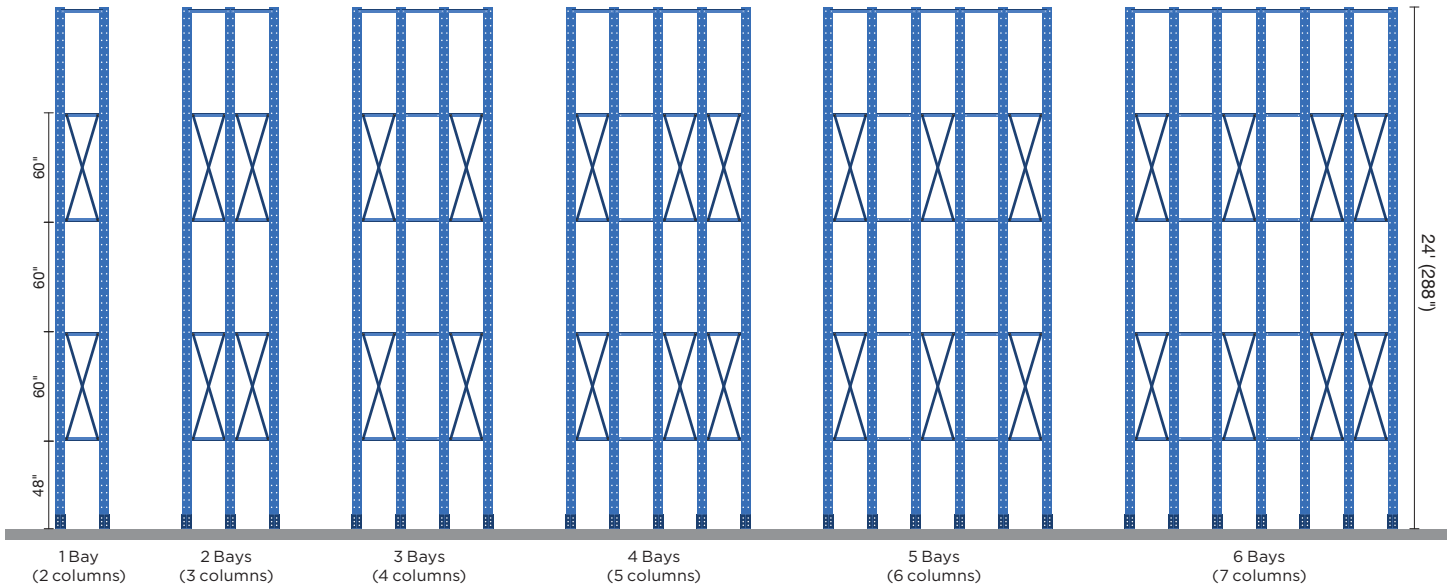

26' (312") COLUMNS

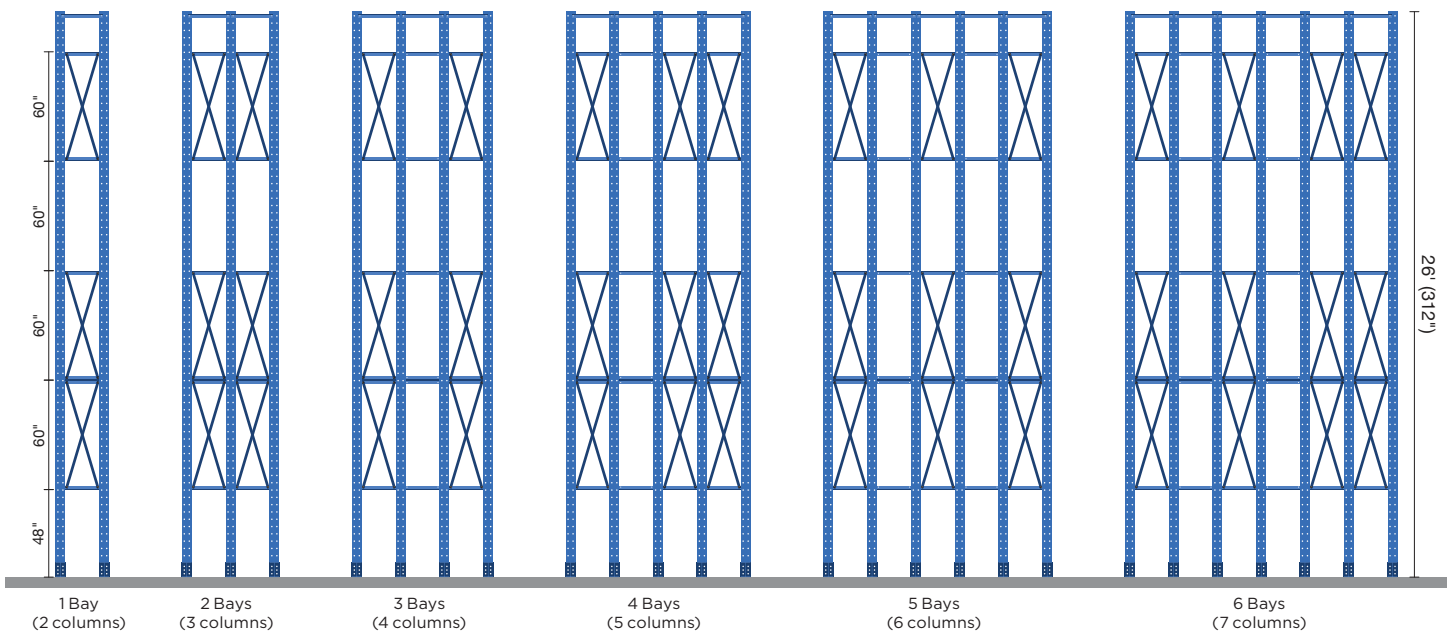

H23 BRACING SCHEMATICS

28' (336") COLUMNS

H23 cantilever rows will have alternating "X" braces starting from the first bay.
When the number of bays is even then there will be 2 bays with "X" bracing at the end of the row.

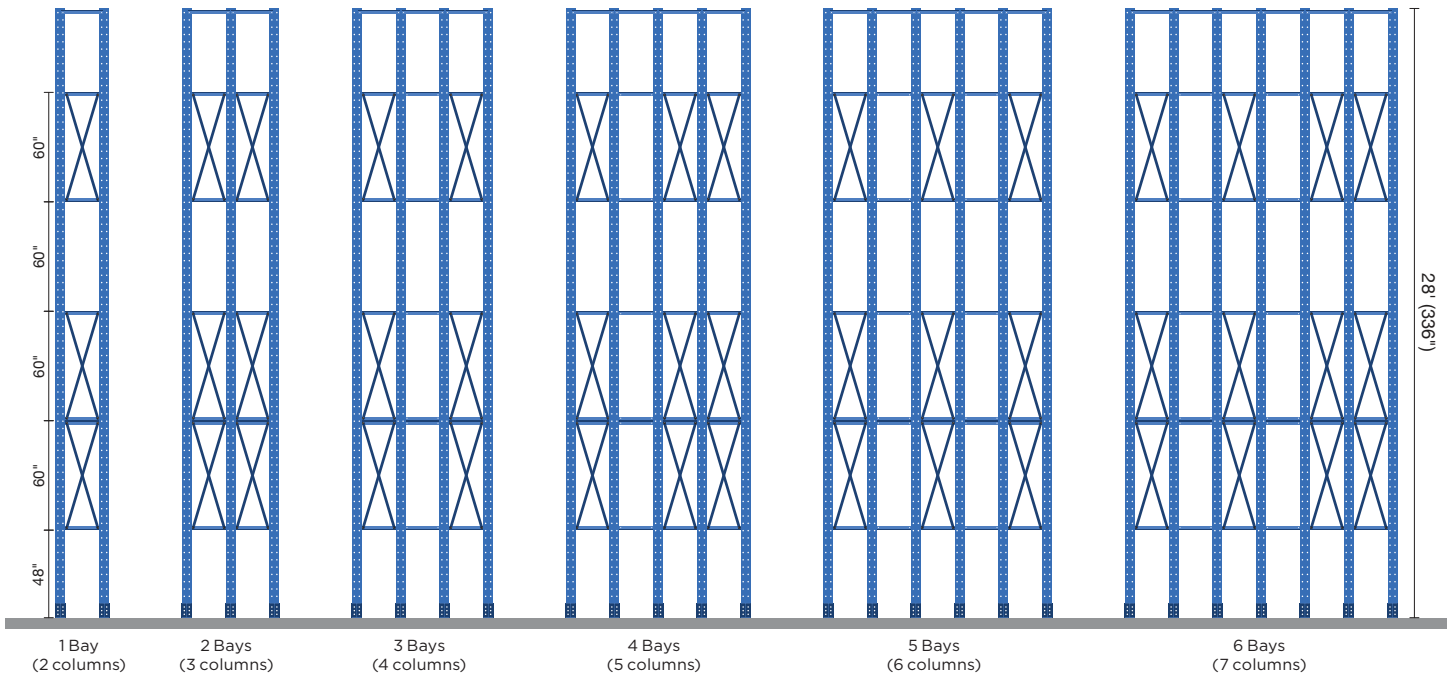

30' (360") COLUMNS

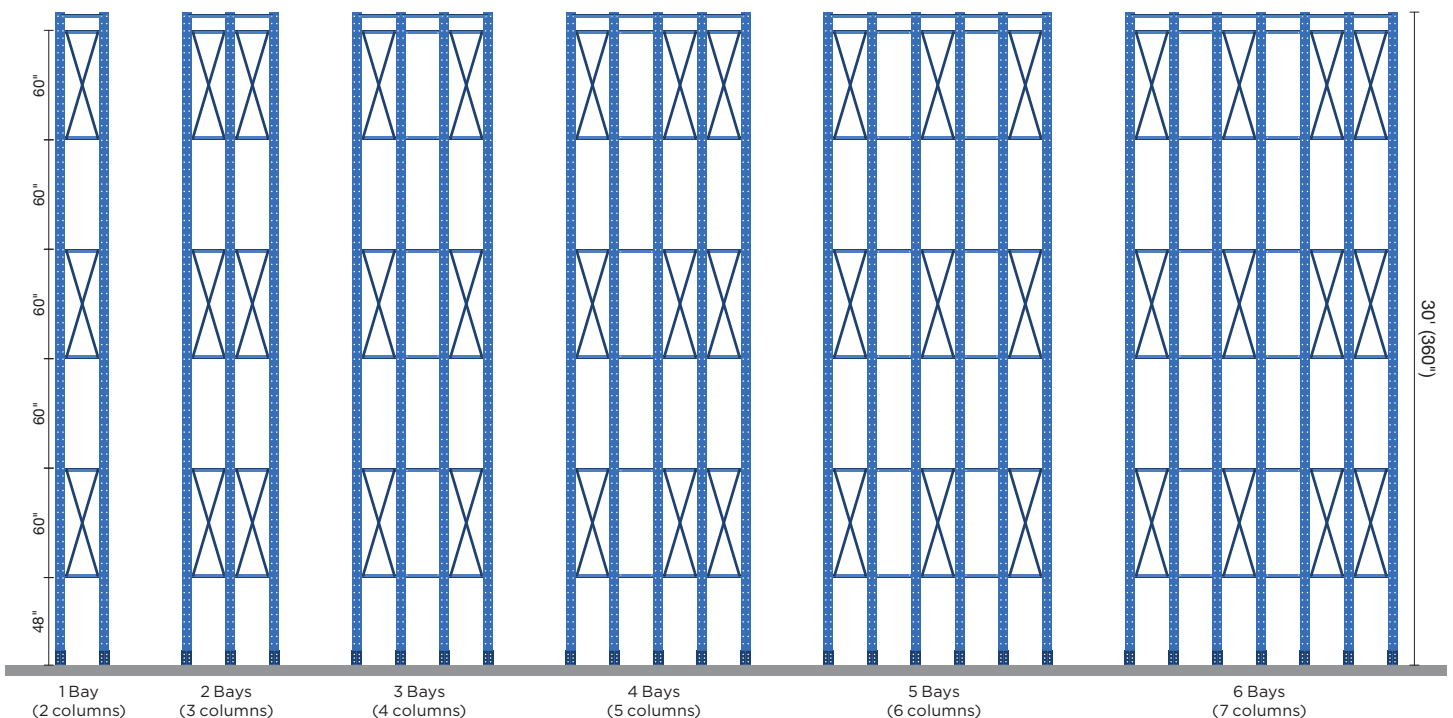

H23 BRACING SCHEMATICS

32' (384") COLUMNS

H23 cantilever rows will have alternating "X" braces starting from the first bay.
When the number of bays is even then there will be 2 bays with "X" bracing at the end of the row.

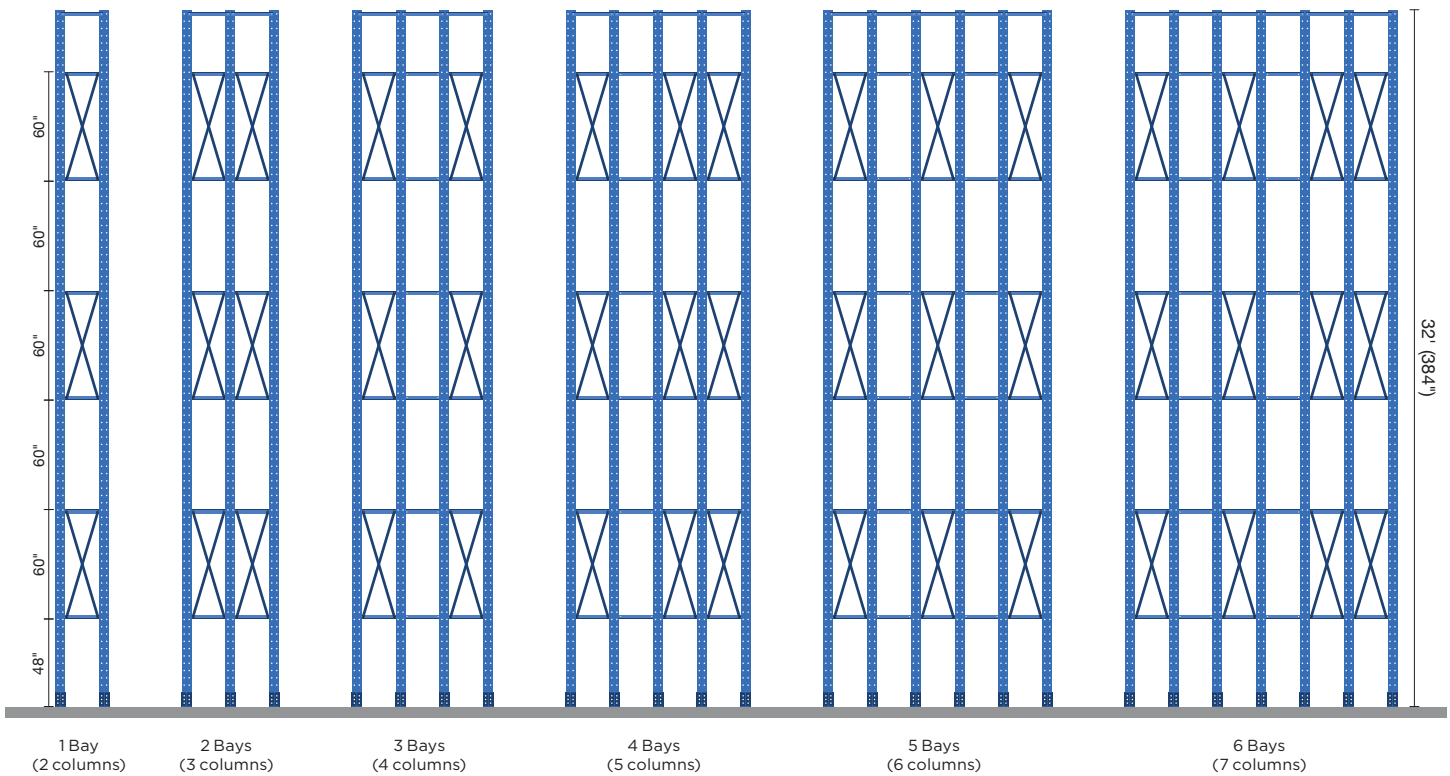

NOTE:

For W8" X 18 and W8" X 24 columns, 32' and higher needs double bracing in both directions. To define this type of solution, contact Interlake Mecalux Engineering.

H23 BRACING SCHEMATICS

34' (408") COLUMNS

H23 cantilever rows will have alternating "X" braces starting from the first bay.
When the number of bays is even then there will be 2 bays with "X" bracing at the end of the row.

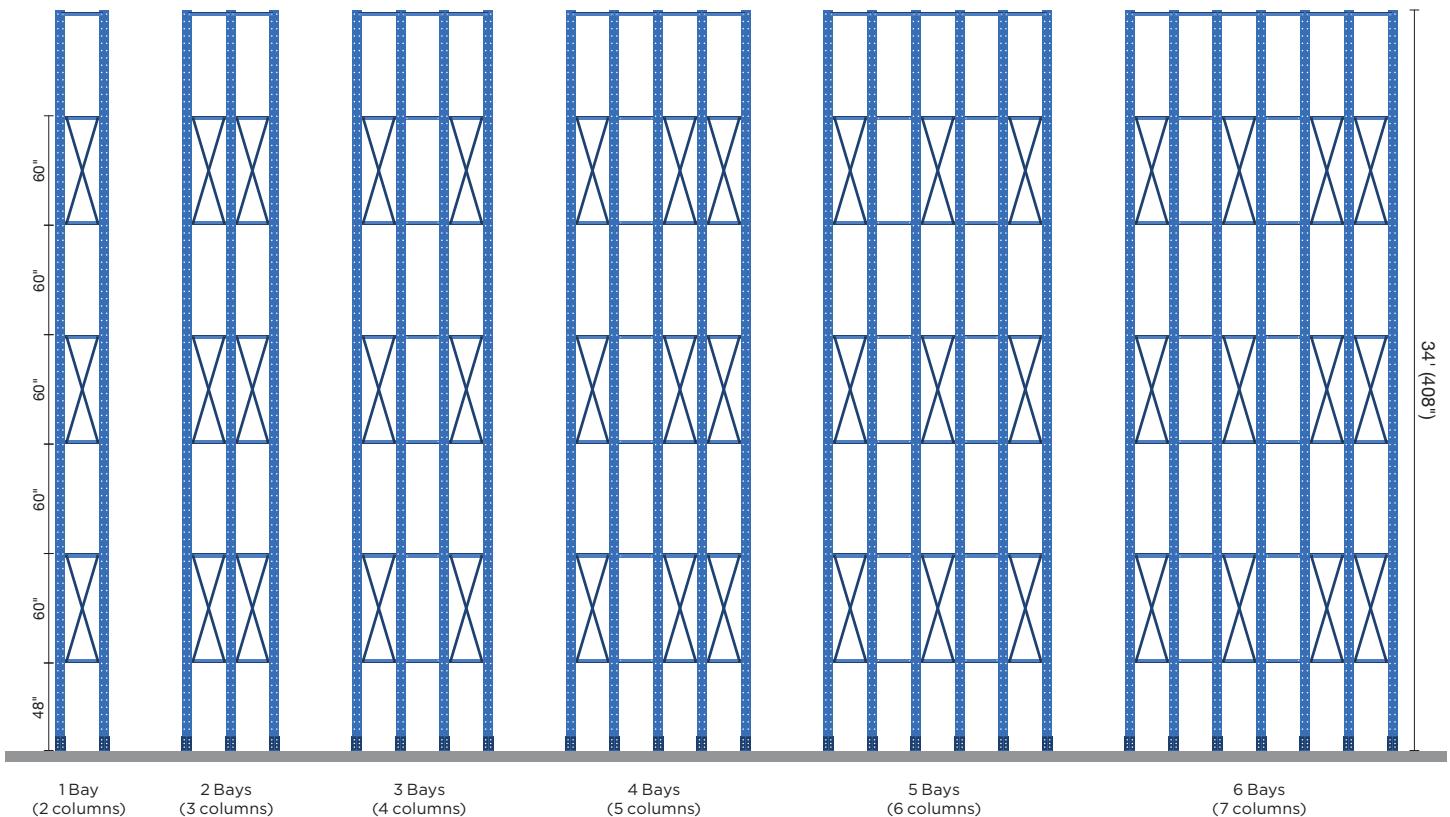

NOTE:

For W8" X 18 and W8" X 24 columns, 32' and higher needs double bracing in both directions.
To define this type of solution, contact Interlake Mecalux Engineering.

H23 BRACING SCHEMATICS

36' (432") COLUMNS

H23 cantilever rows will have alternating "X" braces starting from the first bay.
When the number of bays is even then there will be 2 bays with "X" bracing at the end of the row.

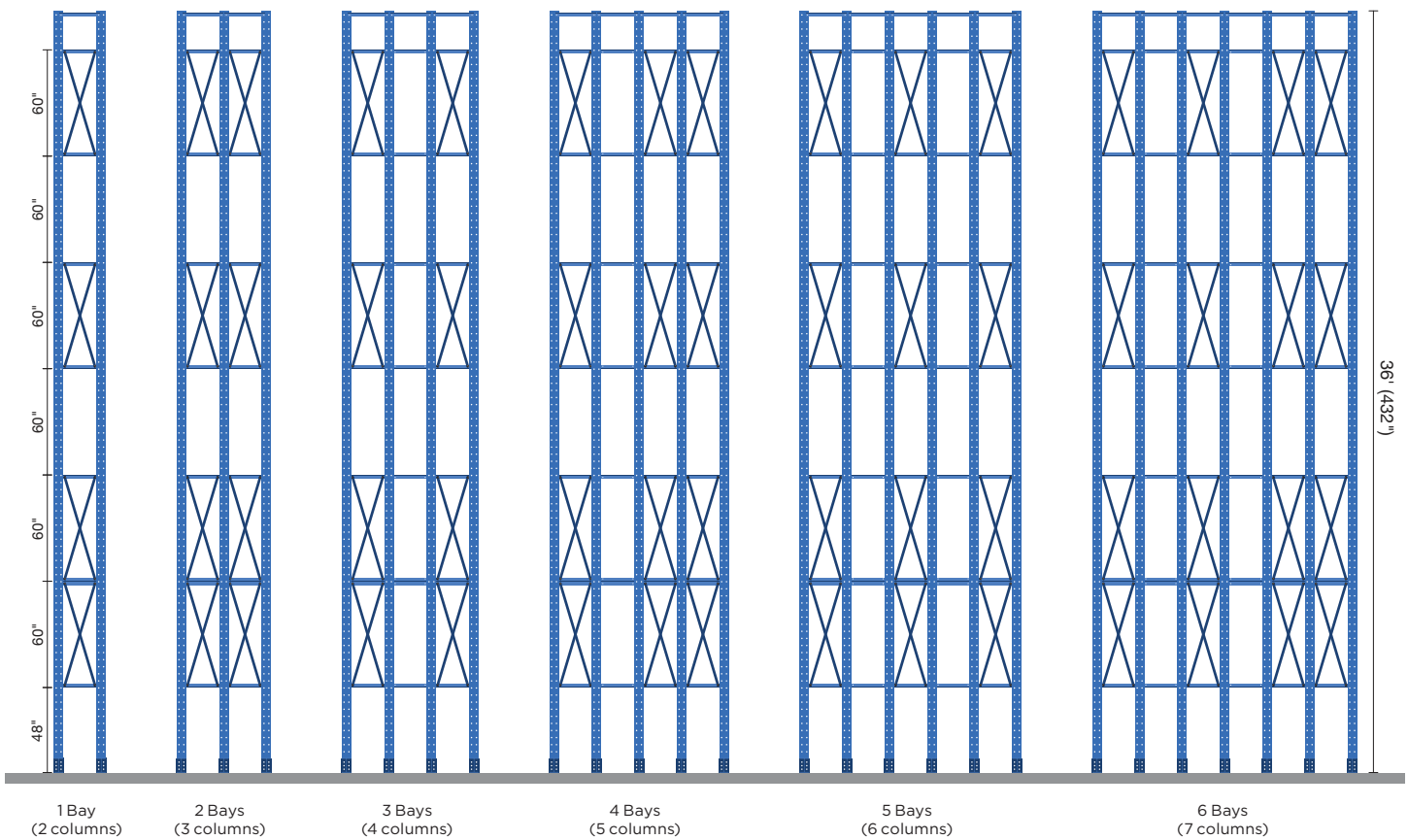

NOTE:

For W8" X 18 and W8" X 24 columns, 32' and higher needs double bracing in both directions. To define this type of solution, contact Interlake Mecalux Engineering.

H23 BRACING SCHEMATICS

38' (456") COLUMNS

H23 cantilever rows will have alternating "X" braces starting from the first bay.
When the number of bays is even then there will be 2 bays with "X" bracing at the end of the row.

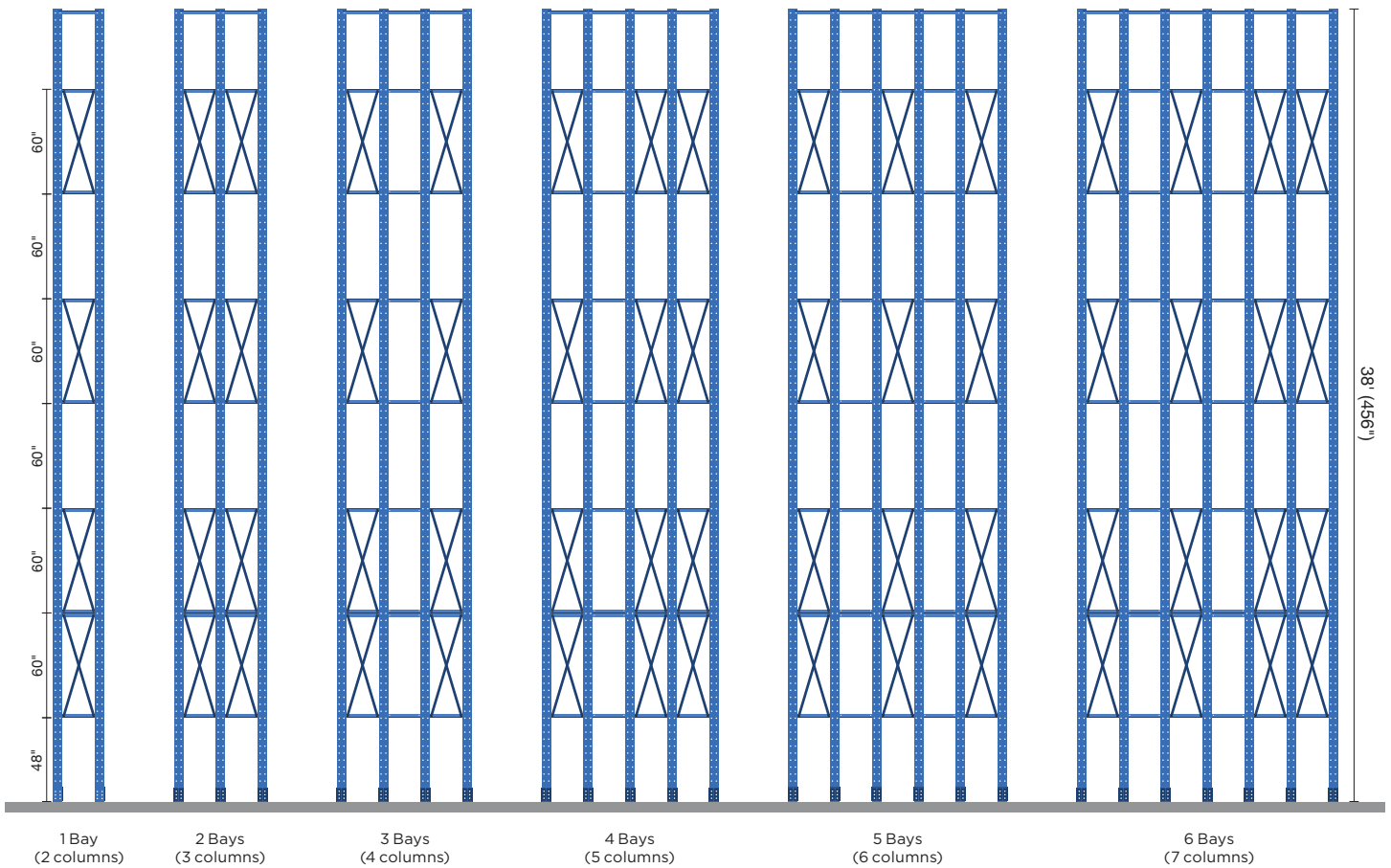

NOTE:

For W8" X 18 and W8" X 24 columns, 32' and higher needs double bracing in both directions.
To define this type of solution, contact Interlake Mecalux Engineering.

H23 CANTILEVER ARM CAPACITY

| Arm Capacities - Uniformly Distributed Loads (lb) | | | | | |
|---|-----------------|-------|-------|-------|-------|
| Arm | Arm Length (in) | | | | |
| | 24" | 36" | 48" | 60" | 72" |
| S3" X 5.7 | 3,320 | 2,210 | 1,640 | 1,310 | 1,080 |
| S4" X 7.7 | 4,640 | 3,090 | 2,300 | 1,830 | 1,510 |
| S5" X 10 | 7,000 | 4,610 | 3,480 | 2,770 | 2,280 |
| S6" X 12.5 | 8,300 | 5,530 | 4,120 | 3,290 | 2,710 |

- Based on R.M.I. Cantilever specification.
- Capacities are based on uniformly distributed loads on arms and the loads' depth **should never exceed** the arms' length.
- Applicable for **non-seismic** use only.
- Effect on impact loads has been taken into account for the static analysis.
- Values shown reflect the capacity of the arms based on the lesser of its strength bending, deflection criteria or arm to column connection capacity.
- The weight of the arms is included.
- Capacities are only valid when used with Interlake Mecalux components.

H23 SINGLE SIDED LATERAL COLUMN CAPACITY

| Single Sided Lateral Column Capacity (lb) | | | | | | | | | | | | | |
|---|---------------|-----------------|-------|-------|-------|------------|-----------------|---------------|-----------------|-------|-------|-------|-------|
| Column Model | Column Height | Arm Length (in) | | | | | Column Model | Column Height | Arm Length (in) | | | | |
| | | 24" | 36" | 48" | 60" | 72" | | | 24" | 36" | 48" | 60" | 72" |
| W8" X 18 | 8' | 12,200 | 9,000 | 7,200 | 5,900 | 5,100 | W8" X 24 | 8' | 12,500 | 9,200 | 7,300 | 6,000 | 5,100 |
| | 10' | 12,200 | 9,000 | 7,200 | 5,900 | 5,100 | | 10' | 12,500 | 9,200 | 7,300 | 6,000 | 5,100 |
| | 12' | 12,200 | 9,000 | 7,200 | 5,900 | 5,100 | | 12' | 12,500 | 9,200 | 7,300 | 6,000 | 5,100 |
| | 14' | 12,200 | 9,000 | 7,200 | 5,900 | 5,100 | | 14' | 12,500 | 9,200 | 7,300 | 6,000 | 5,100 |
| | 16' | 12,200 | 9,000 | 7,200 | 5,900 | 5,100 | | 16' | 12,500 | 9,200 | 7,300 | 6,000 | 5,100 |
| | 18' | 12,150 | 8,975 | 7,175 | 5,900 | 5,100 | | 18' | 12,400 | 9,175 | 7,275 | 6,000 | 5,100 |
| | 20' | 12,100 | 8,950 | 7,150 | 5,900 | 5,100 | | 20' | 12,300 | 9,150 | 7,250 | 6,000 | 5,100 |
| | 22' | 12,050 | 8,925 | 7,125 | 5,900 | 5,100 | | 22' | 12,200 | 9,125 | 7,225 | 6,000 | 5,100 |
| | 24' | 12,000 | 8,900 | 7,100 | 5,900 | 5,100 | | 24' | 12,100 | 9,100 | 7,200 | 6,000 | 5,100 |
| | 26' | 12,000 | 8,900 | 7,100 | 5,900 | 5,100 | | 26' | 12,100 | 9,100 | 7,200 | 6,000 | 5,100 |
| | 28' | 12,000 | 8,900 | 7,100 | 5,900 | 5,100 | | 28' | 12,100 | 9,100 | 7,200 | 6,000 | 5,100 |
| | 30' | 12,000 | 8,900 | 7,100 | 5,900 | 5,100 | | 30' | 12,100 | 9,100 | 7,200 | 6,000 | 5,100 |
| | 32' | 12,000 | 8,900 | 7,100 | 5,900 | 5,100 | | 32' | 12,100 | 9,100 | 7,200 | 6,000 | 5,100 |
| | 34' | 11,840 | 8,900 | 7,100 | 5,900 | 5,100 | | 34' | 12,067 | 9,100 | 7,200 | 6,000 | 5,080 |
| 36' | 11,680 | 8,900 | 7,100 | 5,900 | 5,100 | 36' | 12,033 | 9,100 | 7,200 | 6,000 | 5,060 | | |
| 38' | 11,520 | 8,900 | 7,100 | 5,900 | 5,100 | 38' | 12,000 | 9,100 | 7,200 | 6,000 | 5,040 | | |

NOTE:

For W8" X 18 and W8" X 24 columns, 32' and higher needs double bracing in both directions. To define this type of solution, contact Interlake Mecalux Engineering. Column-to-base connection capacity values are from test.

"L" Single Sided Columns

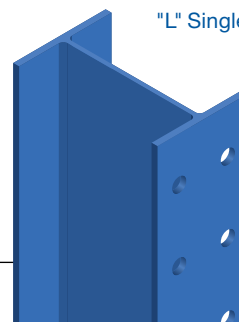

H23 SINGLE SIDED LATERAL COLUMN CAPACITY

| Single Sided Lateral Column Capacity (lb) | | | | | | |
|---|---------------|-----------------|--------|--------|--------|-------|
| Column Model | Column Height | Arm Length (in) | | | | |
| | | 24" | 36" | 48" | 60" | 72" |
| W10" X 26 | 8' | 18,200 | 13,700 | 10,900 | 8,900 | 7,600 |
| | 10' | 18,200 | 13,700 | 10,888 | 8,900 | 7,600 |
| | 12' | 18,200 | 13,700 | 10,875 | 8,900 | 7,600 |
| | 14' | 18,200 | 13,700 | 10,863 | 8,900 | 7,600 |
| | 16' | 18,200 | 13,700 | 10,850 | 8,900 | 7,600 |
| | 18' | 18,200 | 13,700 | 10,838 | 8,900 | 7,600 |
| | 20' | 18,200 | 13,700 | 10,825 | 8,900 | 7,600 |
| | 22' | 18,200 | 13,700 | 10,813 | 8,900 | 7,600 |
| | 24' | 18,200 | 13,700 | 10,800 | 8,900 | 7,600 |
| | 26' | 18,200 | 13,700 | 10,800 | 8,900 | 7,600 |
| | 28' | 18,200 | 13,700 | 10,800 | 8,900 | 7,600 |
| | 30' | 18,200 | 13,700 | 10,800 | 8,900 | 7,600 |
| | 32' | 18,200 | 13,700 | 10,800 | 8,900 | 7,600 |
| | 34' | 18,200 | 13,700 | 10,800 | 8,900 | 7,600 |
| | 36' | 18,200 | 13,700 | 10,800 | 8,900 | 7,600 |
| 38' | 18,200 | 13,700 | 10,800 | 8,900 | 7,600 | |
| W12" X 30 | 8' | 22,500 | 17,200 | 13,700 | 11,400 | 9,800 |
| | 10' | 22,500 | 17,200 | 13,700 | 11,400 | 9,800 |
| | 12' | 22,500 | 17,200 | 13,700 | 11,400 | 9,800 |
| | 14' | 22,500 | 17,200 | 13,700 | 11,400 | 9,800 |
| | 16' | 22,500 | 17,200 | 13,700 | 11,400 | 9,800 |
| | 18' | 22,500 | 17,200 | 13,700 | 11,400 | 9,800 |
| | 20' | 22,500 | 17,200 | 13,700 | 11,400 | 9,800 |
| | 22' | 22,500 | 17,200 | 13,700 | 11,400 | 9,800 |
| | 24' | 22,500 | 17,200 | 13,700 | 11,400 | 9,800 |
| | 26' | 22,500 | 17,200 | 13,700 | 11,400 | 9,800 |
| | 28' | 22,500 | 17,200 | 13,700 | 11,400 | 9,800 |
| | 30' | 22,500 | 17,200 | 13,700 | 11,400 | 9,800 |
| | 32' | 22,500 | 17,200 | 13,700 | 11,400 | 9,800 |
| | 34' | 22,500 | 17,200 | 13,700 | 11,400 | 9,800 |
| | 36' | 22,500 | 17,200 | 13,700 | 11,400 | 9,800 |
| 38' | 22,500 | 17,200 | 13,700 | 11,400 | 9,800 | |

Column capacity charts assume even spacing between arm levels, if arm levels require different spacing consult with Interlake Mecalux Engineering.

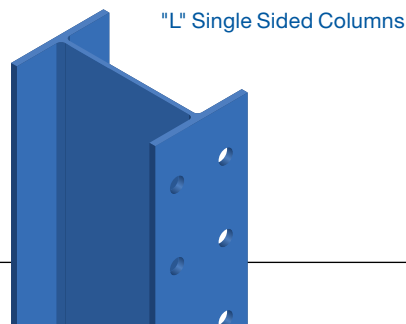

H23 CANTILEVER ARM CAPACITY

| Arm Capacities - Uniformly Distributed Loads (lb) | | | | | |
|---|-----------------|-------|-------|-------|-------|
| Arm | Arm Length (in) | | | | |
| | 24" | 36" | 48" | 60" | 72" |
| S3" X 5.7 | 3,320 | 2,210 | 1,640 | 1,310 | 1,080 |
| S4" X 7.7 | 4,640 | 3,090 | 2,300 | 1,830 | 1,510 |
| S5" X 10 | 7,000 | 4,610 | 3,480 | 2,770 | 2,280 |
| S6" X 12.5 | 8,300 | 5,530 | 4,120 | 3,290 | 2,710 |

- Based on R.M.I. Cantilever specification.
- Capacities are based on uniformly distributed loads on arms and the loads' depth **should never exceed** the arms' length.
- Applicable for **non-seismic** use only.
- Effect on impact loads has been taken into account for the static analysis.
- Values shown reflect the capacity of the arms based on the lesser of its strength bending, deflection criteria or arm to column connection capacity.
- The weight of the arms is included.
- Capacities are only valid when used with Interlake Mecalux components.

H23 DOUBLE SIDED LATERAL COLUMN CAPACITY

| Single Sided Lateral Column Capacity (lb) | | | | | | | | | | | | | |
|---|---------------|-----------------|--------|--------|--------|------------|-----------------|---------------|-----------------|--------|--------|--------|--------|
| Column Model | Column Height | Arm Length (in) | | | | | Column Model | Column Height | Arm Length (in) | | | | |
| | | 24" | 36" | 48" | 60" | 72" | | | 24" | 36" | 48" | 60" | 72" |
| W8" X 18 | 8' | 24,400 | 18,000 | 14,400 | 11,800 | 10,200 | W8" X 24 | 8' | 25,000 | 18,400 | 14,600 | 12,000 | 10,200 |
| | 10' | 24,400 | 18,000 | 14,400 | 11,800 | 10,200 | | 10' | 25,000 | 18,400 | 14,600 | 12,000 | 10,200 |
| | 12' | 24,400 | 18,000 | 14,400 | 11,800 | 10,200 | | 12' | 25,000 | 18,400 | 14,600 | 12,000 | 10,200 |
| | 14' | 24,400 | 18,000 | 14,400 | 11,800 | 10,200 | | 14' | 25,000 | 18,400 | 14,600 | 12,000 | 10,200 |
| | 16' | 24,400 | 18,000 | 14,400 | 11,800 | 10,200 | | 16' | 25,000 | 18,400 | 14,600 | 12,000 | 10,200 |
| | 18' | 24,300 | 17,950 | 14,350 | 11,800 | 10,200 | | 18' | 24,800 | 18,350 | 14,550 | 12,000 | 10,200 |
| | 20' | 24,200 | 17,900 | 14,300 | 11,800 | 10,200 | | 20' | 24,600 | 18,300 | 14,500 | 12,000 | 10,200 |
| | 22' | 24,100 | 17,850 | 14,250 | 11,800 | 10,200 | | 22' | 24,400 | 18,250 | 14,450 | 12,000 | 10,200 |
| | 24' | 24,000 | 17,800 | 14,200 | 11,800 | 10,200 | | 24' | 24,200 | 18,200 | 14,400 | 12,000 | 10,200 |
| | 26' | 24,000 | 17,800 | 14,200 | 11,800 | 10,200 | | 26' | 24,200 | 18,200 | 14,400 | 12,000 | 10,200 |
| | 28' | 24,000 | 17,800 | 14,200 | 11,800 | 10,200 | | 28' | 24,200 | 18,200 | 14,400 | 12,000 | 10,200 |
| | 30' | 24,000 | 17,800 | 14,200 | 11,800 | 10,200 | | 30' | 24,200 | 18,200 | 14,400 | 12,000 | 10,200 |
| | 32' | 24,000 | 17,800 | 14,200 | 11,800 | 10,200 | | 32' | 24,200 | 18,200 | 14,400 | 12,000 | 10,200 |
| | 34' | 23,680 | 17,800 | 14,200 | 11,800 | 10,200 | | 34' | 24,134 | 18,200 | 14,400 | 12,000 | 10,160 |
| 36' | 23,360 | 17,800 | 14,200 | 11,800 | 10,200 | 36' | 24,066 | 18,200 | 14,400 | 12,000 | 10,120 | | |
| 38' | 23,040 | 17,800 | 14,200 | 11,800 | 10,200 | 38' | 24,000 | 18,200 | 14,400 | 12,000 | 10,080 | | |

NOTE:

For W8" X 18 and W8" X 24 columns, 32' and higher needs double bracing in both directions. To define this type of solution, contact Interlake Mecalux Engineering. Column-to-base connection capacity values are from test.

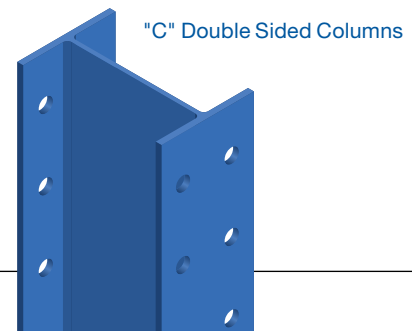

H23 DOUBLE SIDED LATERAL COLUMN CAPACITY

| Single Sided Lateral Column Capacity (lb) | | | | | | |
|---|---------------|-----------------|--------|--------|--------|--------|
| Column Model | Column Height | Arm Length (in) | | | | |
| | | 24" | 36" | 48" | 60" | 72" |
| W10" X 26 | 8' | 36,400 | 27,400 | 21,800 | 17,800 | 15,200 |
| | 10' | 36,400 | 27,400 | 21,776 | 17,800 | 15,200 |
| | 12' | 36,400 | 27,400 | 21,750 | 17,800 | 15,200 |
| | 14' | 36,400 | 27,400 | 21,726 | 17,800 | 15,200 |
| | 16' | 36,400 | 27,400 | 21,700 | 17,800 | 15,200 |
| | 18' | 36,400 | 27,400 | 21,676 | 17,800 | 15,200 |
| | 20' | 36,400 | 27,400 | 21,650 | 17,800 | 15,200 |
| | 22' | 36,400 | 27,400 | 21,626 | 17,800 | 15,200 |
| | 24' | 36,400 | 27,400 | 21,600 | 17,800 | 15,200 |
| | 26' | 36,400 | 27,400 | 21,600 | 17,800 | 15,200 |
| | 28' | 36,400 | 27,400 | 21,600 | 17,800 | 15,200 |
| | 30' | 36,400 | 27,400 | 21,600 | 17,800 | 15,200 |
| | 32' | 36,400 | 27,400 | 21,600 | 17,800 | 15,200 |
| | 34' | 36,400 | 27,400 | 21,600 | 17,800 | 15,200 |
| | 36' | 36,400 | 27,400 | 21,600 | 17,800 | 15,200 |
| 38' | 36,400 | 27,400 | 21,600 | 17,800 | 15,200 | |
| W12" X 30 | 8' | 45,000 | 34,400 | 27,400 | 22,800 | 19,600 |
| | 10' | 45,000 | 34,400 | 27,400 | 22,800 | 19,600 |
| | 12' | 45,000 | 34,400 | 27,400 | 22,800 | 19,600 |
| | 14' | 45,000 | 34,400 | 27,400 | 22,800 | 19,600 |
| | 16' | 45,000 | 34,400 | 27,400 | 22,800 | 19,600 |
| | 18' | 45,000 | 34,400 | 27,400 | 22,800 | 19,600 |
| | 20' | 45,000 | 34,400 | 27,400 | 22,800 | 19,600 |
| | 22' | 45,000 | 34,400 | 27,400 | 22,800 | 19,600 |
| | 24' | 45,000 | 34,400 | 27,400 | 22,800 | 19,600 |
| | 26' | 45,000 | 34,400 | 27,400 | 22,800 | 19,600 |
| | 28' | 45,000 | 34,400 | 27,400 | 22,800 | 19,600 |
| | 30' | 45,000 | 34,400 | 27,400 | 22,800 | 19,600 |
| | 32' | 45,000 | 34,400 | 27,400 | 22,800 | 19,600 |
| | 34' | 45,000 | 34,400 | 27,400 | 22,800 | 19,600 |
| | 36' | 45,000 | 34,400 | 27,400 | 22,800 | 19,600 |
| 38' | 45,000 | 34,400 | 27,400 | 22,800 | 19,600 | |

Column capacity charts assume even spacing between arm levels, if arm levels require different spacing consult with Interlake Mecalux Engineering.

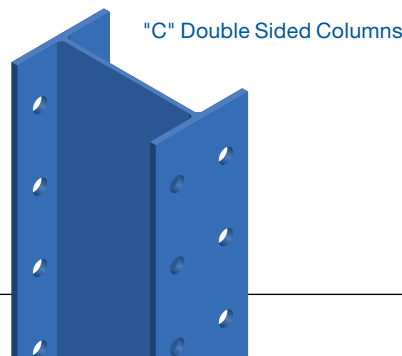

H23 SINGLE SIDED V DOUBLE SIDED CAPACITY EXAMPLE

Request: Load per arm is 1,400 lbs, arm length is 48", column will have 6 levels (5 arms + base) evenly spaced, column height is 16' (192").
48" Arm S3" X 5.7 has a max. capacity of 1,640 lbs.

Single Sided: 5 arms x 1,400 = 7,000 lbs / W8" X 18 has a max. capacity of 7,200 lbs when Single Sided.

Double Sided: 10 arms X 1,400 = 14,000 lbs / W8" X 18 has a max. capacity of 14,400 when Double Sided.

| Arm Model | Length |
|------------|--------|
| | 48" |
| S3" X 5.7 | 1,640 |
| S4" X 7.7 | 2,300 |
| S5" X 10 | 3,480 |
| S6" X 12.5 | 4,120 |

| Column Model | Column Height | Single Sided | Double Sided |
|--------------|---------------|--------------|--------------|
| | | Arm Length | Arm Length |
| | | 48" | 48" |
| W8" X 18 | 16' (192") | 7,200 | 14,400 |
| W8" X 24 | | 7,300 | 14,600 |
| W10" X 26 | | 10,850 | 21,700 |
| W12" X 30 | | 13,700 | 27,400 |

SINGLE SIDED "L" COLUMN PROFILE VIEW

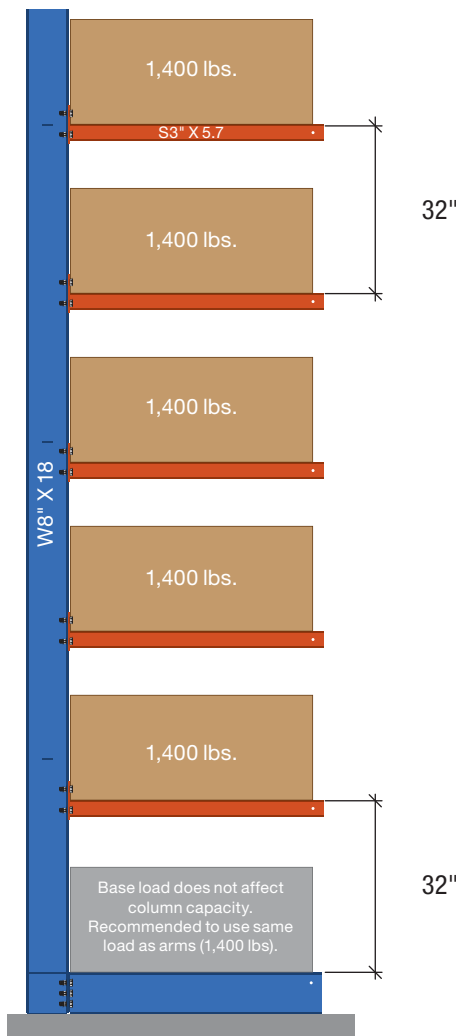

DOUBLE SIDED "C" COLUMN PROFILE VIEW

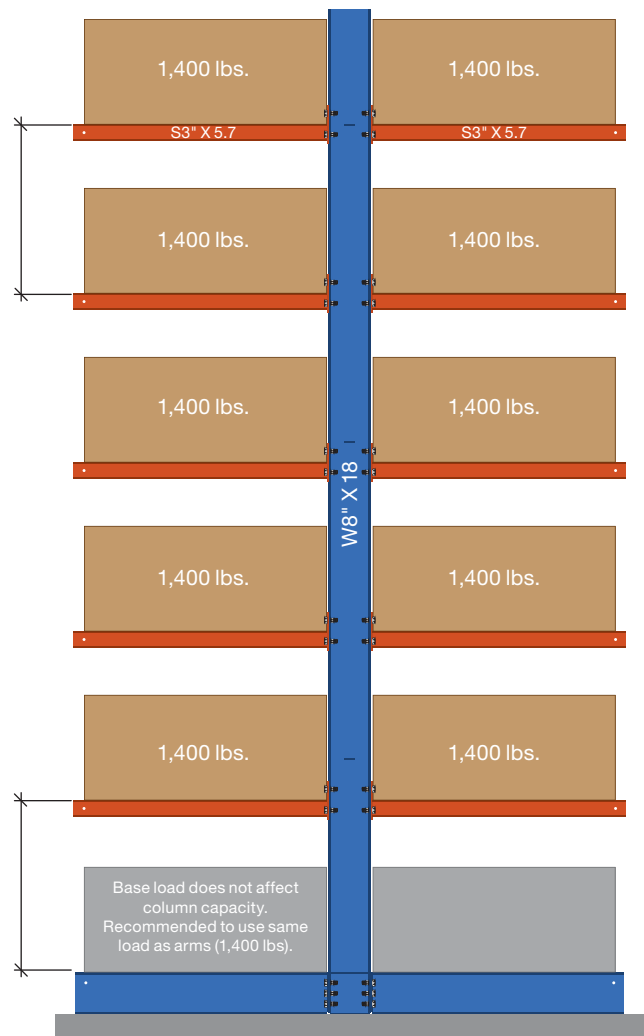

Interlake



Tel. 1-877-632-2589 - info@interlakemecalux.com - interlakemecalux.com

SALES OFFICES

CHICAGO
1600 North 25th Ave.
Melrose Park, IL 60160

DALLAS
12301 N Stemmons Freeway,
Suite # 110
Farmers Branch, TX 75234

SAN DIEGO
8607 Ave. De La Fuente
San Diego, CA 92154

PRODUCTION PLANTS

CHICAGO
1600 North 25th Avenue
Melrose Park, IL 60160

MATAMOROS
Las Rusias 2700,
Industrial del Norte
Matamoros Tamaulipas,
C.P. 87316

PONTIAC
701 Interlake Drive
Pontiac, IL 61764

TIJUANA
Blvd. Bellas Artes, 9001
Ciudad Industrial Nueva Tijuana
Tijuana, B.C. - C.P. 22444

OFFICES WORLDWIDE

Argentina, Belgium, Brazil, Canada, Chile, Czechia, Colombia, France, Germany, Holland, Italy, Mexico, Peru, Poland, Portugal, Slovakia, Spain, Turkey, United Kingdom and Uruguay.

