



CARTON FLOW



General Features of Carton Flow

The versatile Interlake Mecalux Carton Flow system is made up of slightly inclined wheel and roller platforms. Goods are deposited on the high end of the rack allowing gravity to pull the products down to the far end, positioned at the exit aisle, creating a first-in/first-out picking system.

The racking for live picking requires a loading or replenishment aisle and a preparation aisle.

Advantages of the System

The most important benefits of the Carton Flow system are:

- **Perfect product turnover**
- **Greatest number of references** at the front of the rack
- **Reduced time** for order preparation
- **Reduced personnel movement inefficiencies**
- **Greater storage capacity**
- **Optional compatibility** with pick-to-light system

Basic Components

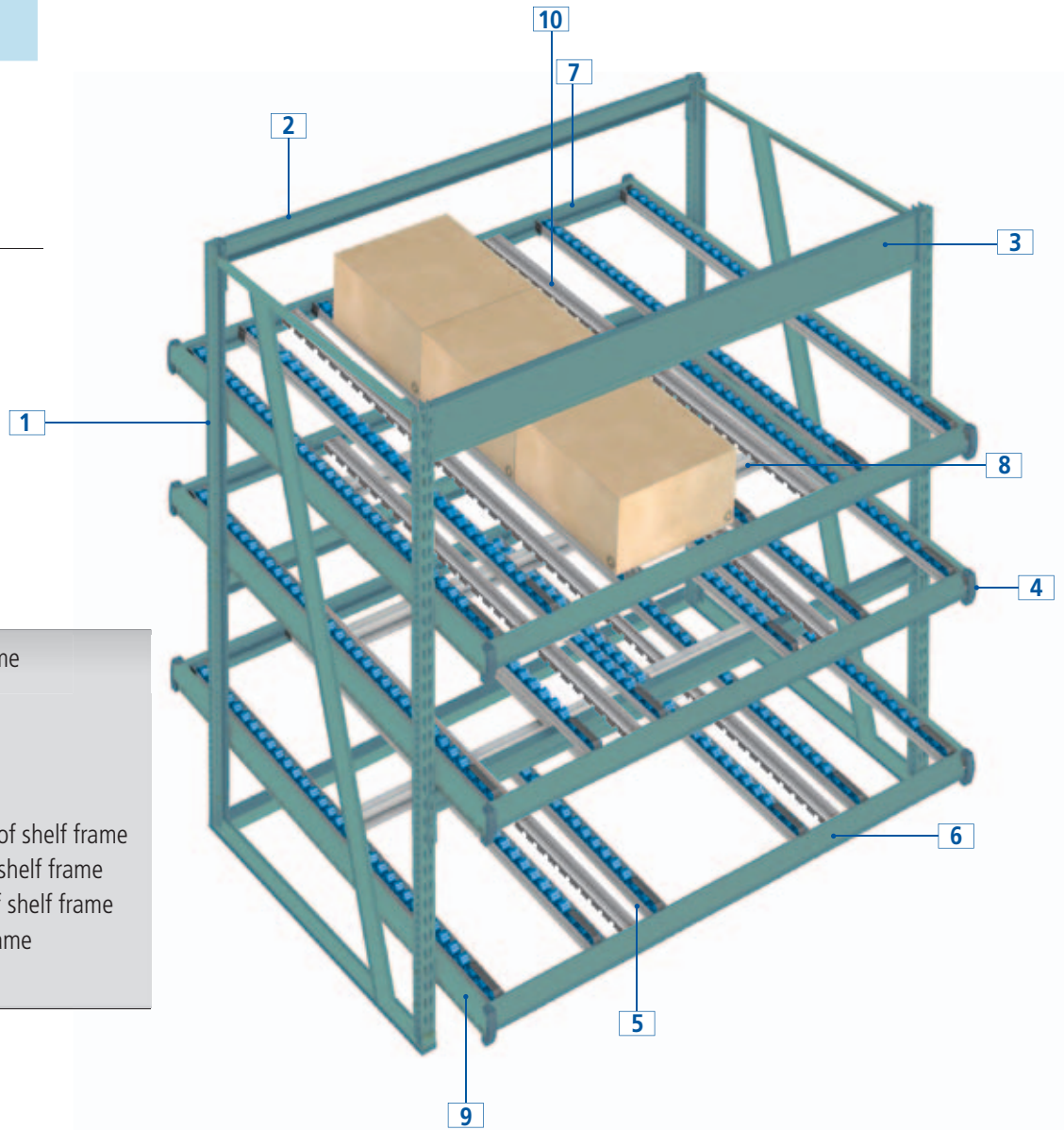

- 1/ Square Carton Flow frame
- 2/ Angle brace
- 3/ Sway brace
- 4/ Shelf frame
- 5/ Wheel track
- 6/ Discharge end member of shelf frame
- 7/ Charge end member of shelf frame
- 8/ Intermediate member of shelf frame
- 9/ Side member of shelf frame
- 10/ Guide (if required)

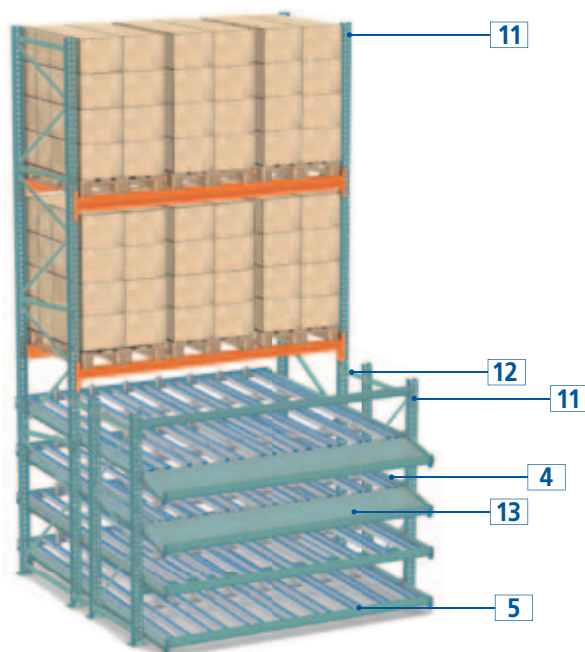

Optional Configurations

- 11/ Welded selective frame with Carton Flow punching
- 12/ Row spacer
- 13/ Tilt panel

The supplementary configuration options are not included with the basic components but are recommended to ensure the added security of your goods and efficiency of your system. Please contact an Interlake Mecalux representative to evaluate further options.



Standard Shelves

The shelf units with custom sized lanes are built using adjustable platforms made up of side panels, entry profiles, exit beams, cross-ties, mini-rails and securing components.

Charge and discharge side of shelf frame can be individually adjusted (vertical location of the frame) in order to find the most ergonomic position. The rails can also be adjusted in order to find the ideal position for each box.

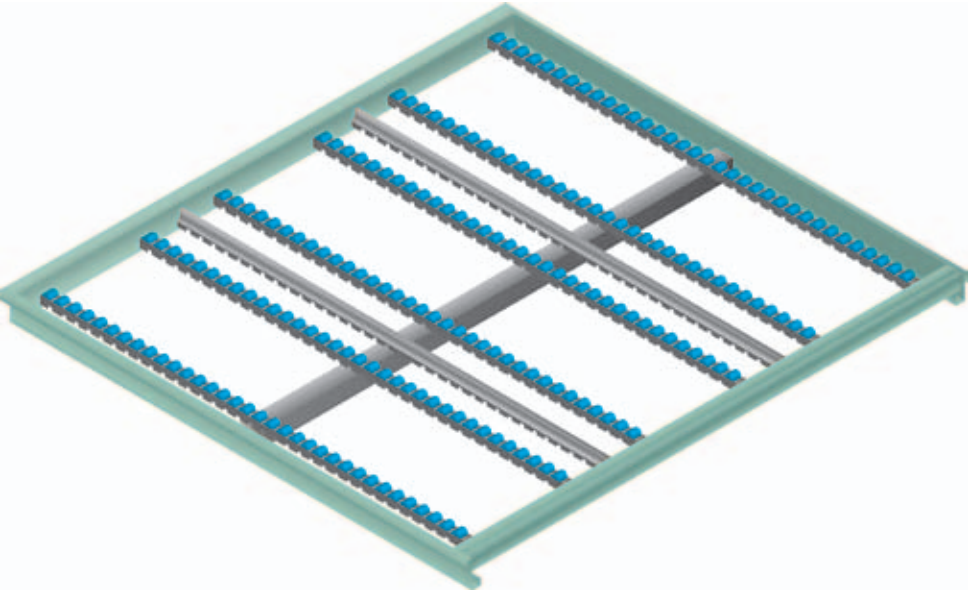

Shelf units with custom sized lanes may be installed into standard pallet rack frames or in stand-alone Carton Flow frames as shown below.

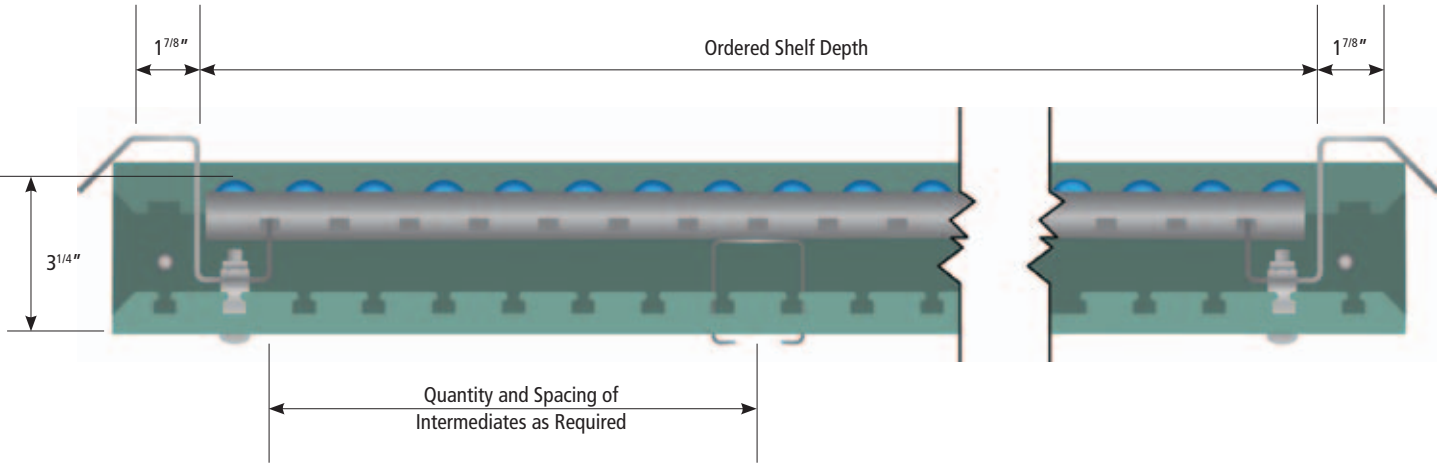

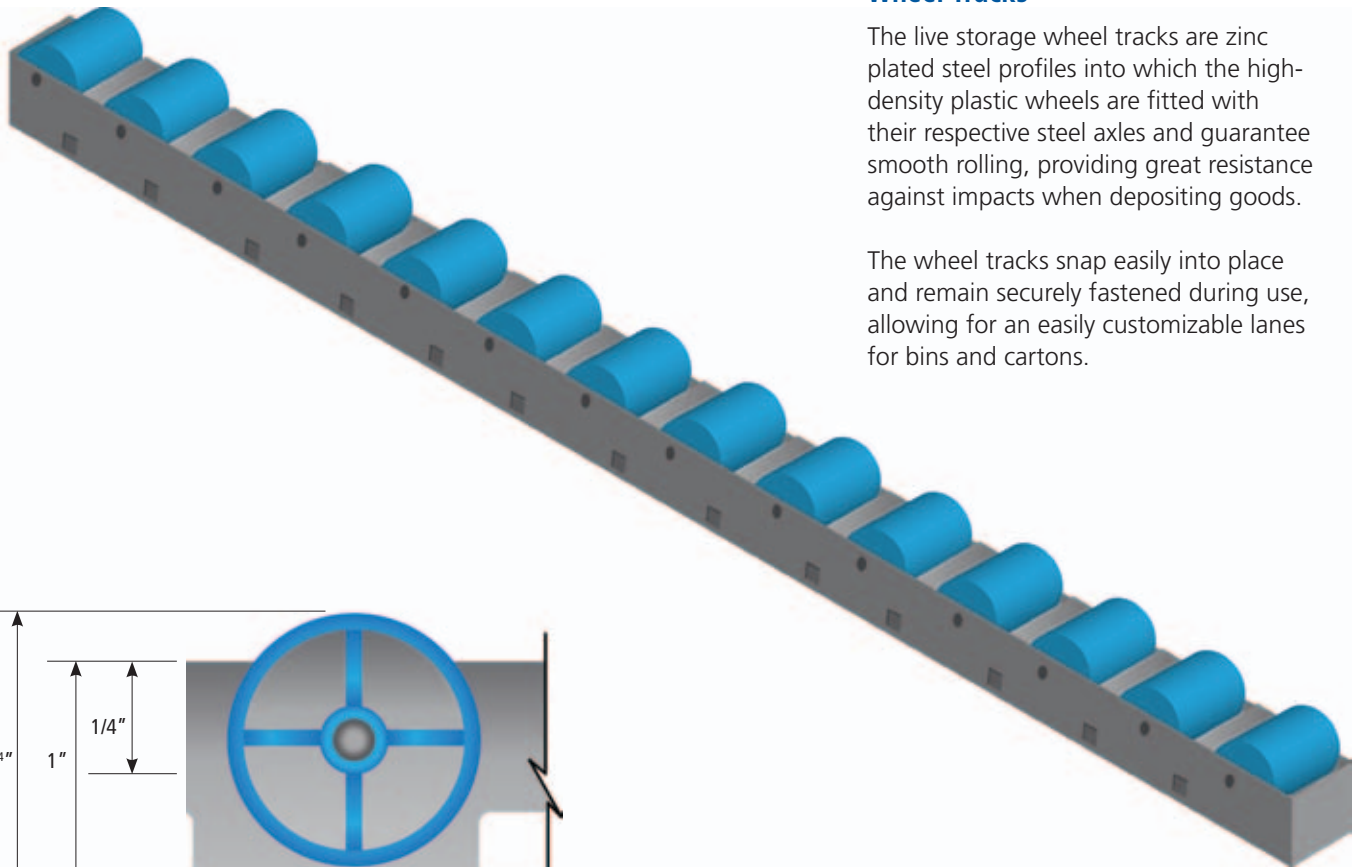

Wheel Tracks

The live storage wheel tracks are zinc plated steel profiles into which the high-density plastic wheels are fitted with their respective steel axles and guarantee smooth rolling, providing great resistance against impacts when depositing goods.

The wheel tracks snap easily into place and remain securely fastened during use, allowing for an easily customizable lanes for bins and cartons.

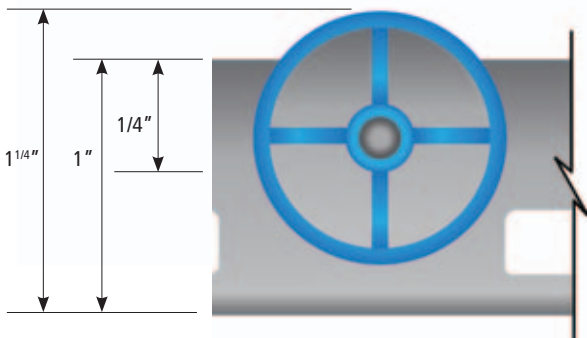



Frames

The Carton Flow frames are available in three different widths in the square configuration. This style is fully adjustable and supports multiple shelf units to create a first-in/first-out picking system (FIFO).

Contact your Interlake Mecalux sales representative for details.

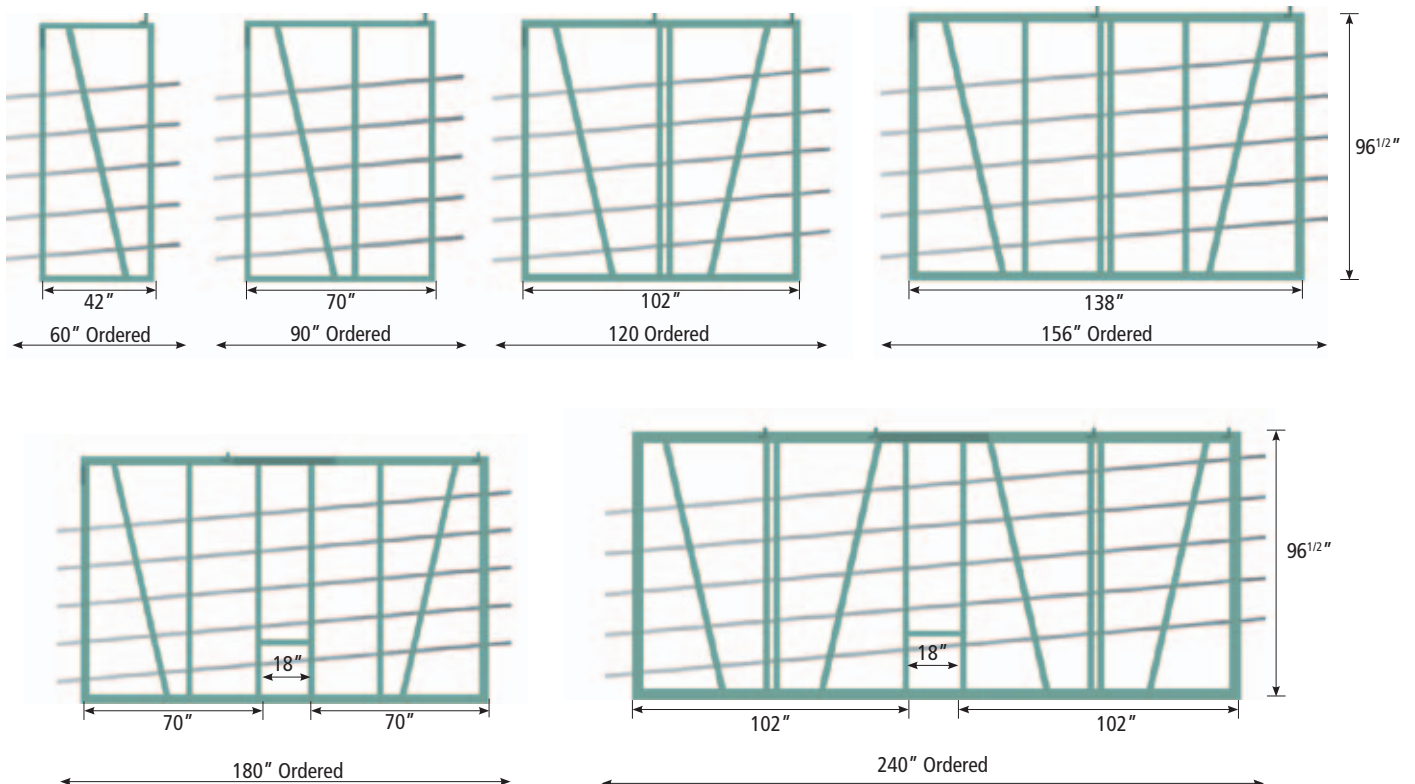

Accessories

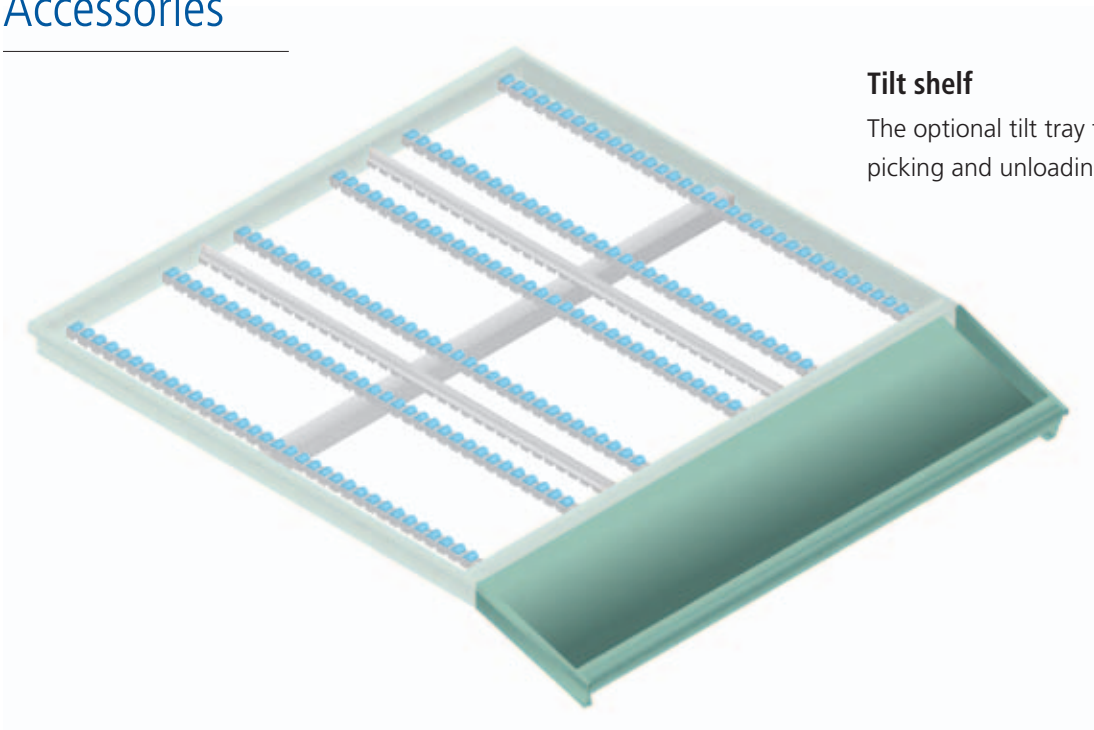

Tilt shelf

The optional tilt tray feature facilitates picking and unloading operations.

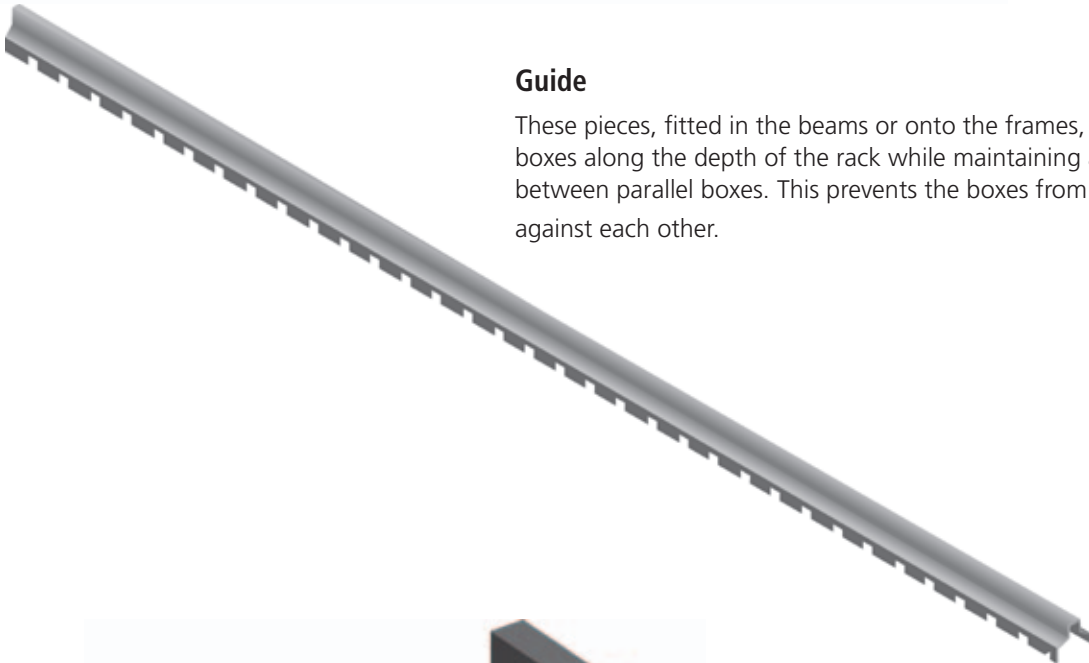

Guide

These pieces, fitted in the beams or onto the frames, guide the boxes along the depth of the rack while maintaining a fixed space between parallel boxes. This prevents the boxes from brushing up against each other.

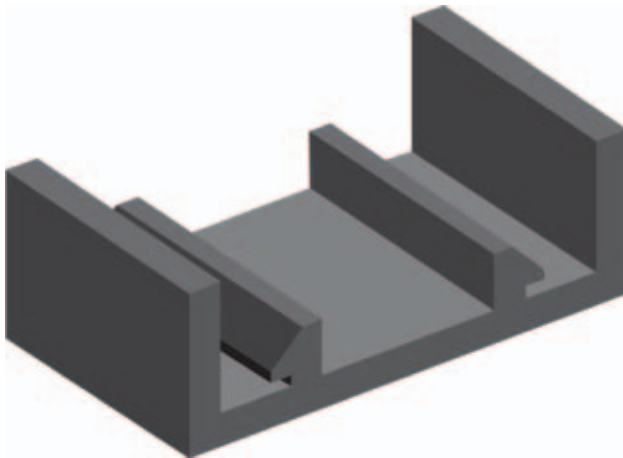

Clips

A fixing clip centered with the holes in the entry and exit profiles secures the wheel track to the frame.



e-mail: info@interlakemecalux.com - interlakemecalux.com

SALES OFFICES

CHICAGO
Tel. 1-708-344-9999
1600 North 25th Ave.
Melrose Park, IL 60160

DALLAS
Tel. 1-972-245-3910
12301 N Stemmons Freeway,
Suite 110
Farmers Branch, TX 75234

SAN DIEGO
Tel. 1-619-671-0335
8607 Ave. De La Fuente
San Diego, CA 92154

PRODUCTION PLANTS

CHICAGO
Tel. 1-708-344-9999
1600 North 25th Avenue
Melrose Park, IL 60160

MATAMOROS
Tel. (868) 811 44 00
Las Rusias 2700, Industrial
del Norte
Matamoros Tamaulipas -
C.P. 87316

PONTIAC
Tel. 1-877-632-2589
701 Interlake Drive
Pontiac, IL 61764

TIJUANA
Tel. (664) 647 22 00
Blvd. Bellas Artes, 9001
Ciudad Industrial Nueva Tijuana
Tijuana, B.C. - C.P. 22444

OFFICES WORLDWIDE

Argentina, Belgium, Brazil, Canada, Chile, Czechia, Colombia, France, Germany, Holland, Italy, Mexico, Peru, Poland, Portugal, Slovakia, Spain, Turkey, United Kingdom, Uruguay and USA.

